NARROW (Ultra-V) DRIVES



NARROW (ULTRA-V) SHEAVE FEATURES

Wood's Ultra-V sheaves are constructed of fine grain, high tensile cast iron, and have been carefully engineered to assure maximum performance over a long life span. Behind each sheave is one of the most extensive engineering design and testing programs in the industry.



With the advent of higher V-belt ratings, Wood's engineers instituted additional careful test programs to ensure that each Wood's sheave would be capable of safely and dependably delivering the increased performance which was required by the new ratings. Wood's engineers, using a special strain gage test stand, subject sheaves to tension and compression stresses far in excess of those encountered in actual operation.

In another standard test procedure, Wood's sheaves are operated at extremely high speeds. Sheaves are selected from warehouse stocks and tested until they are burst by centrifugal force. Such destructive testing allows Wood's engineers to study the effects of construction and balance on sheave performance. The goal is to assure safe operation at normal speeds. Other continuing programs check product quality in the laboratory and on the manufacturing line.

For applications with special requirements, Wood's sheaves are also available on a made-to-order basis in either cast or ductile iron, and in Sure-Grip or bored-to-suit construction.

Wood's stock narrow sheaves are available with the convenient Sure-Grip QD type bushing. Easy to install and remove, these split, tapered bushings grip the shaft with the equivalent of a shrink fit. This tight holding power eliminates freezing and fretting corrosion between the shaft and the bore and assures quick removal and interchangeability when necessary.

Stock sheaves are designed to carry the loads of all belts shown in this catalog and other similarly rated V-Belts. For special higher rated V-Belts, consult Wood's Engineering Department for recommendations.



We cast or stamp the maximum safe operating speed, in rpm, on all sheaves we manufacture.

NARROW (ULTRA-V) SHEAVE GROOVE DETAILS



STANDARD GROOVE DIMENSIONS

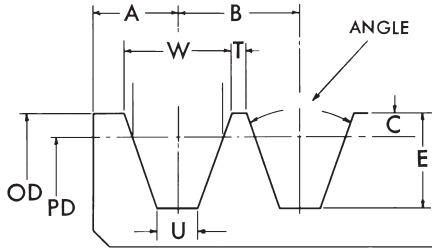

Belt	GROOVE DIMENSIONS IN INCHES								
	A	B	C	E	W	T	U	Angle of Groove	Used on O.D.
3V	11/32	13/32	0	.350	.350	.056	.123	36°	Under 3.5
							.109	38°	3.5 to 6.0
							.095	40°	6.01 to 12.0
							.081	42°	12.01, Over
5V	1/2	11/16	0	.600	.600	.0875	.187	38°	Under 10.0
							.163	40°	10.1 to 16.0
							.139	42°	16.01, Over
8V	3/4	1 1/8	0	1.000	1.000	.125	.312	38°	Under 16.0
							.272	40°	16.0 to 22.4
							.232	42°	22.41, Over

STANDARD SHEAVE FACE WIDTHS

Belt	FACE WIDTH OF SHEAVE IN INCHES																		For Each Additional Groove Add
	1	2	3	4	5	6	7	8	9	10	11	12	13	14	15	16	17	18	
3V	11/16*	13/32	1 1/2	1 29/32	2 5/16	2 23/32	3 1/8	3 17/32	3 15/16	4 11/32	4 3/4	5 5/32	5 9/16	5 31/32	6 3/8	6 25/32	7 3/16	7 19/32	13/32
5V	1	1 11/16	2 3/8	3 1/16	3 3/4	4 7/16	5 1/8	5 13/16	6 1/2	7 3/16	7 7/8	8 9/16	9 1/4	9 15/16	10 5/8	11 5/16	12	12 11/16	1 1/16
8V**	1 1/2	2 5/8	3 3/4	4 7/8	6	7 1/8	8 1/4	9 3/8	10 1/2	11 5/8	12 3/4	13 7/8	15	16 1/8	17 1/4	18 3/4	19 7/8	21	1 1/8

* For 10.6 to 13.9 outside diameters face width = 3/4". For outside diameters 14.0 and over face width = 13/16.

** Sheaves 16 grooves and over have 3/8" additional metal added to overall face width.

DEEP GROOVE DIMENSIONS

Belt	GROOVE DIMENSIONS IN INCHES								
	A	B	C	E	W	T	U	Angle of Groove	Used on O.D.
3V	3/8	1/2	.109	.459	.421	.079	.123	36°	Under 3.72
					.425	.075	.109	38°	3.72 to 6.22
					.429	.071	.095	40°	6.23 to 12.22
					.434	.067	.081	42°	12.22, Over
5V	9/16	13/16	.160	.760	.710	.102	.187	38°	Under 10.32
					.716	.096	.163	40°	10.32 to 16.32
					.723	.090	.139	42°	16.32, Over
8V	27/32	1 5/16	.262	1.262	1.180	.132	.312	38°	Under 16.52
					1.191	.123	.272	40°	16.52 to 22.92
					1.201	.113	.232	42°	22.92, Over

DEEP GROOVE SHEAVE FACE WIDTHS

Belt	FACE WIDTH OF SHEAVE IN INCHES																		For Each Additional Groove Add
	1	2	3	4	5	6	7	8	9	10	11	12	13	14	15	16	17	18	
3V	3/4	1 1/4	1 3/4	2 1/4	2 3/4	3 1/4	3 3/4	4 1/4	4 3/4	5 1/4	5 3/4	6 1/4	6 3/4	7 1/4	7 3/4	8 1/4	8 3/4	9 1/4	1/2
5V	1 1/8	1 15/16	2 3/4	3 3/16	4 3/8	5 3/16	6	6 13/16	7 7/8	8 7/16	9 1/4	10 1/16	10 7/8	11 11/16	12 1/2	13 5/16	14 1/8	14 15/16	13/16
8V	1 11/16	3	4 5/16	5 5/8	6 15/16	8 1/4	9 3/16	10 7/8	12 3/16	13 1/2	14 13/16	16 1/8	17 7/16	18 3/4	20 1/16	21 3/8	22 11/16	24	1 5/16

These sheaves are designed to carry the loads of all belts shown in this catalog and other similarly rated V-Belts. For special higher rated V-Belts, consult Wood's Engineering Department for recommendations.

The sheaves listed below are all stock sizes. The dimensions given are with the Sure-Grip bushings in place. When ordering, specify the bushing, if required, and the bore size. The figure following the letter in the "Type" column indicates the sheave construction: 1 – Solid, 2 – Web, 3 – Arms.

DIMENSIONS (In Inches)

O.D. ◆	I.D.	Product No.	1 GROOVE							Product No.	2 GROOVE						
			*F = 11/16								F = 1-3/32						
			Bush.	Type	E	K	L	M	Wt.		Bush.	Type	E	K	L	M	Wt.
2.20 †	...	3V221	JA	E1	19/32	7/16	1	29/32	0.9	3V222	JA	E1	1	7/16	1	29/32	1.1
2.35 †	...	3V2351	JA	E1	19/32	7/16	1	29/32	1.2	3V2352	JA	E1	1	7/16	1	29/32	1.4
2.50 †	...	3V251	JA	E1	19/32	7/16	1	29/32	1.3	3V252	JA	E1	1	7/16	1	29/32	1.5
2.65	2.00	3V2651	JA	D1	13/32	1/16	1	3/32	0.9	3V2652	JA	D1	11/32	1/8	1	7/16	1.2
2.80	2.00	3V281	JA	D1	13/32	1/16	1	3/32	1.0	3V282	JA	D1	11/32	1/8	1	7/16	1.3
3.00	2.00	3V301	JA	D1	13/32	1/16	1	3/32	1.1	3V302	JA	D1	11/32	1/8	1	7/16	1.5
3.15	2.00	3V3151	JA	D1	13/32	1/32	1	3/32	1.2	3V3152	JA	D1	11/32	1/8	1	7/16	1.7
3.35	2.00	3V3.351	JA	D1	13/32	1/16	1	3/32	1.4	3V3.352	SH	D1	7/16	1/8	1-1/4	9/32	1.9
3.65	2.68	3V3651	SH	C1	9/16	0	1-1/4	0	2.0	3V3652	SH	D1	7/16	1/8	1-1/4	9/32	2.4
4.12	2.88	3V4121	SH	C1	9/16	0	1-1/4	0	2.5	3V4122	SH	D1	1/4	5/16	1-1/4	3/32	2.9
4.50	3.18	3V451	SH	C1	9/16	0	1-1/4	0	3.0	3V452	SH	D1	1/4	5/16	1-1/4	3/32	3.5
4.75	3.44	3V4751	SH	C1	9/16	0	1-1/4	0	3.3	3V4752	SH	D1	1/4	5/16	1-1/4	3/32	3.9
5.00	3.68	3V501	SH	C1	9/16	0	1-1/4	0	3.6	3V502	SH	D1	1/4	5/16	1-1/4	3/32	4.2
5.30	4.00	3V531	SH	C1	9/16	0	1-1/4	0	3.8	3V532	SH	D1	1/4	5/16	1-1/4	3/32	4.7
5.60	4.25	3V561	SH	C1	9/16	0	1-1/4	0	4.2	3V562	SH	D1	1/4	5/16	1-1/4	3/32	5.3
6.00	4.69	3V601	SH	C2	9/16	0	1-1/4	0	4.2	3V602	SH	D2	1/4	5/16	1-1/4	3/32	6.2
6.50	5.25	3V651	SH	C2	9/16	0	1-1/4	0	4.6	3V652	SDS	D1	5/16	5/16	1-5/16	3/32	7.5
6.90	5.62	3V691	SH	C2	9/16	0	1-1/4	0	4.5	3V692	SDS	D2	5/16	5/16	1-5/16	3/32	6.7
8.00	6.68	3V801	SDS	C2	5/8	0	1-5/16	0	7.0	3V802	SDS	D2	5/16	5/16	1-5/16	3/32	7.4
10.60	9.25	3V1061	SDS	D3	5/8	0	1-5/16	1/16	7.4	3V1062	SK	C3	15/32	1/4	1-7/8	5/16	13.1
14.00	12.62	3V1401	SK	C3	21/32	0	1-7/8	11/32	14.4	3V1402	SK	C3	15/32	1/4	1-7/8	5/16	19.6
19.00	17.50	3V1901	SK	C3	21/32	0	1-7/8	11/32	20.6	3V1902	SK	C3	15/32	1/4	1-7/8	5/16	24.2
25.00	3V2502	SF	C3	7/16	1/4	2	15/32	40.7

*F = 3/4 for 10.60 inches O.D. – F = 13/16 for 14.00 inches and 19.00 inches O.D.

O.D. ◆	I.D.	Product No.	3 GROOVE							Product No.	4 GROOVE						
			F = 1-1/2								F = 1-29/32						
			Bush.	Type	E	K	L	M	Wt.		Bush.	Type	E	K	L	M	Wt.
2.50 †	...	3V253	JA	E1	1-13/32	7/16	1	29/32	1.8
2.65	2.00	3V2653	JA	E1	27/32	-1/8	1	11/32	1.5	3V2654	JA	E1	1-1/4	-1/8	1	11/32	1.8
2.80	2.00	3V283	JA	E1	27/32	-1/8	1	11/32	1.6	3V284	JA	E1	1-1/4	-1/8	1	11/32	1.9
3.00	1.81	3V303	SH	E1	1-3/16	3/8	1-1/4	15/16	2.3	3V304	SH	E1	1-19/32	3/8	1-1/4	15/16	2.6
3.15	1.81	3V3153	SH	E1	1-3/16	3/8	1-1/4	15/16	2.6	3V3154	SH	E1	1-19/32	3/8	1-1/4	15/16	3.0
3.35	2.68	3V3.353	SH	D1	7/16	1/8	1-1/4	11/16	2.4	3V3.354	SH	D1	7/16	1/8	1-1/4	1-3/32	2.8
3.65	2.68	3V3653	SH	D1	7/16	1/8	1-1/4	11/16	3.0	3V3654	SH	D1	7/16	1/8	1-1/4	1-3/32	3.6
4.12	2.88	3V4123	SH	A1	1/8	11/16	1-1/4	1/8	3.4	3V4124	SH	A1	1/4	13/16	1-1/4	11/32	3.9
4.50	3.31	3V453	SDS	A1	1/16	11/16	1-5/16	1/8	4.1	3V454	SDS	A1	3/16	13/16	1-5/16	13/32	4.5
4.75	3.44	3V4753	SDS	A1	1/16	11/16	1-5/16	1/8	4.6	3V4754	SDS	A1	3/16	13/16	1-5/16	13/32	5.1
5.00	3.68	3V503	SDS	A1	1/16	11/16	1-5/16	1/8	5.0	3V504	SDS	A1	3/16	13/16	1-5/16	13/32	5.6
5.30	4.07	3V533	SDS	A1	1/16	11/16	1-5/16	1/8	5.6	3V534	SDS	A1	3/16	13/16	1-5/16	13/32	6.1
5.60	4.36	3V563	SDS	A1	1/16	11/16	1-5/16	1/8	6.5	3V564	SDS	A1	3/16	13/16	1-5/16	13/32	7.7
6.00	4.69	3V603	SDS	A1	1/16	11/16	1-5/16	1/8	7.0	3V604	SK	D1	3/32	5/8	1-7/8	1/8	9.8
6.50	5.25	3V653	SDS	A2	1/16	11/16	1-5/16	1/8	7.3	3V654	SK	D1	3/32	5/8	1-7/8	1/8	11.3
6.90	5.62	3V693	SDS	A2	1/16	11/16	1-5/16	1/8	7.8	3V694	SK	D1	3/32	5/8	1-7/8	1/8	12.9
8.00	6.68	3V803	SK	D2	15/32	1/4	1-7/8	3/32	10.6	3V804	SK	D2	3/32	5/8	1-7/8	1/8	12.1
10.60	9.25	3V1063	SK	D3	15.32	1/4	1-7/8	3/32	14.7	3V1064	SK	D3	3/32	5/8	1-7/8	1/8	17.3
14.00	12.62	3V1403	SK	D3	15/32	1/4	1-7/8	3/32	21.1	3V1404	SK	D3	3/32	5/8	1-7/8	1/8	24.1
19.00	17.62	3V1903	SF	C3	7/16	1/4	2	1/16	36.3	3V1904	SF	C3	1/16	5/8	2	1/32	39.3
25.00	23.56	3V2503	SF	C3	7/16	1/4	2	1/16	45.0	3V2504	SF	C3	1/16	5/8	2	1/32	58.3
33.50	31.94	3V3353	SF	C3	7/16	1/4	2	1/16	73.8	3V3354	E	C3	13/32	1/2	2-5/8	5/16	106.3

◆ P.D. = O.D. † Recommended for use with Narrow Cog belts only.
Weights for all Sure-Grip bushed items are approximate and include the bushing.

STOCK NARROW (ULTRA-V) SHEAVES



DIMENSIONS (In Inches)

O.D. ◆	I.D.	Product No.	5 GROOVE F = 2-5/16							Product No.	6 GROOVE F = 2-23/32						
			Bush.	Type	E	K	L	M	Wt.		Bush.	Type	E	K	L	M	Wt.
4.75	3.44	3V4755	SDS	A1	3/16	13/16	1-5/16	13/16	5.7	3V4756	SK	E1	1-7/16	1/8	1-7/8	19/32	7.2
5.00	3.68	3V505	SDS	A1	3/16	13/16	1-5/16	13/16	6.2	3V506	SK	E1	1-7/16	1/8	1-7/8	19/32	8.0
5.30	4.00	3V535	SK	A1	7/32	15/16	1-7/8	7/32	8.2	3V536	SK	A1	19/32	1-5/16	1-7/8	1/4	8.9
5.60	4.31	3V565	SK	A1	7/32	15/16	1-7/8	7/32	9.1	3V566	SK	A1	19/32	1-5/16	1-7/8	1/4	9.8
6.00	4.69	3V605	SK	A1	7/32	15/16	1-7/8	7/32	10.5	3V606	SK	A1	19/32	1-5/16	1-7/8	1/4	11.2
6.50	5.25	3V655	SK	A1	7/32	15/16	1-7/8	7/32	12.1	3V656	SK	A1	19/32	1-5/16	1-7/8	1/4	12.9
6.90	5.62	3V695	SK	A1	7/32	15/16	1-7/8	7/32	13.6	3V696	SK	A1	19/32	1-5/16	1-7/8	1/4	14.5
8.00	6.63	3V805	SK	A2	7/32	15/16	1-7/8	7/32	13.6	3V806	SK	A2	5/32	7/8	1-7/8	11/16	14.7
10.60	9.25	3V1065	SK	A3	7/32	15/16	1-7/8	7/32	18.9	3V1066	SF	A3	3/16	7/8	2	17/32	22.1
14.00	12.62	3V1405	SF	A3	3/16	7/8	2	1/8	29.7	3V1406	SF	A3	3/16	7/8	2	17/32	31.9
19.00	17.62	3V1905	SF	A3	3/16	7/8	2	1/8	46.0	3V1906	E	B3	3/32	1	2-5/8	0	56.5
25.00	23.56	3V2505	E	C3	9/32	5/8	2-5/8	1/32	73.0	3V2506	E	B3	3/32	1	2-5/8	0	84.6
33.50	31.94	3V3355	E	C3	9/32	4/8	2-5/8	1/32	112.7	3V3356	E	B3	3/32	1	2-5/8	0	128.9

O.D. ◆	I.D.	Product No.	8 GROOVE F = 3-17/32							Product No.	10 GROOVE F = 4-11/32						
			Bush.	Type	E	K	L	M	Wt.		Bush.	Type	E	K	L	M	Wt.
4.75	3.88	3V4758	SK	E1	2-1/4	1/8	1-7/8	19/32	9.6	3V47510	SK	E1	3-1/16	1/8	1-7/8	19/32	9.6
5.00	3.88	3V508	SK	E1	2-1/4	1/8	1-7/8	19/32	9.3	3V5010	SK	E1	3-1/16	1/8	1-7/8	19/32	10.5
5.30	4.00	3V538	SK	A1	19/32	1-5/16	1-7/8	1-1/16	10.3	3V5310	SK	A1	23/32	1-7/16	1-7/8	1-3/4	11.6
5.60	4.31	3V568	SK	A1	19/32	1-5/16	1-7/8	1-1/16	11.3	3V5610	SK	A1	23/32	1-7/16	1-7/8	1-3/4	12.7
6.00	4.69	3V608	SK	A1	19/32	1-5/16	1-7/8	1-1/16	12.8	3V6010	SK	A1	23/32	1-7/16	1-7/8	1-3/4	14.4
6.50	5.25	3V658	SK	A1	19/32	1-5/16	1-7/8	1-1/16	14.6	3V6510	SK	A1	23/32	1-7/16	1-7/8	1-3/4	16.2
6.90	5.62	3V698	SK	A1	19/32	1-5/16	1-7/8	1-1/16	16.3	3V6910	SK	A1	23/32	1-7/16	1-7/8	1-3/4	18.1
8.00	6.68	3V808	SF	A1	7/16	1-1/8	2	1-3/32	22.0	3V8010	SF	A1	13/16	1-1/2	2	1-17/32	24.2
10.60	9.25	3V1068	SF	A3	7/16	1-1/8	2	1-3/32	25.2	3V10610	E	A2	11/32	1-1/4	2-5/8	1-3/8	40.1
14.00	12.62	3V1408	E	A3	11/32	1-1/4	2-5/8	9/16	50.3	3V14010	E	A3	11/32	1-1/4	2-5/8	1-3/8	54.7
19.00	17.62	3V1908	E	A3	11/32	1-1/4	2-5/8	9/16	68.4	3V19010	E	A3	11/32	1-1/4	2-5/8	1-3/8	77.6
25.00	23.56	3V2508	E	A3	11/32	1-1/4	2-5/8	9/16	99.3	3V25010	F	A3	1/4	1-5/16	3-5/8	15/32	126.2
33.50	31.94	3V3358	F	B3	0	1-1/16	3-5/8	3/32	154.7	3V33510	F	A3	1/4	1-5/16	3-5/8	15/32	188.4

◆ P.D. = O.D.

Weights for all Sure-Grip bushed items are approximate and include the bushing.

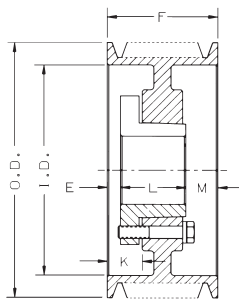

Type A

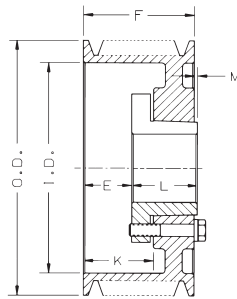

Type B

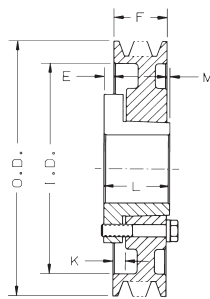

Type C

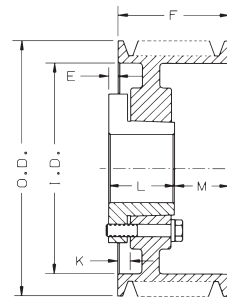

Type D

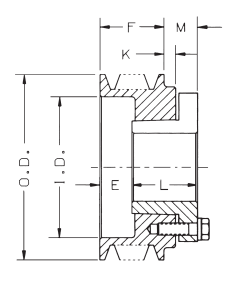

Type E

These sheaves are designed to carry the loads of all belts shown in this catalog and other similarly rated V-Belts. For special higher rated V-Belts, consult Wood's Engineering Department for recommendations.

The sheaves listed below are all stock sizes. The dimensions given are with the Sure-Grip bushings in place. When ordering, specify the bushing, if required, and the bore size. The figure following the letter in the "Type" column indicates the sheave construction: 1 – Solid, 2 – Web, 3 – Arms.

DIMENSIONS (In Inches)

O.D. ◆	I.D.	Product No.	2 GROOVE F = 1-11/16							Product No.	3 GROOVE F = 2-3/8						
			Bush.	Type	E	K	L	M	Wt.		Bush.	Type	E	K	L	M	Wt.
4.4 †	2.72	5V442	SH	A1	1/8	11/16	1-1/4	5/16	4.0	5V443	SDS	E1	1-11/16	0	1-5/16	5/8	5.2
4.65 †	2.94	5V4652	SDS	E1	13/16	3/16	1-5/16	7/16	4.3	5V4653	SDS	E1	1-11/16	0	1-5/16	5/8	5.8
4.9 †	3.25	5V492	SDS	A1	1/16	11/16	1-5/16	5/16	4.8	5V493	SDS	A1	7/16	1-1/16	1-5/16	5/8	6.3
5.2 †	3.50	5V522	SDS	A1	1/16	11/16	1-5/16	5/16	5.4	5V523	SDS	A1	7/16	1-1/16	1-5/16	5/8	6.6
5.5 †	3.75	5V552	SDS	A1	1/16	11/16	1-5/16	5/16	6.1	5V553	SDS	A1	7/16	1-1/16	1-5/16	5/8	7.4
5.9 †	4.18	5V592	SDS	A1	1/16	11/16	1-5/16	5/16	6.8	5V593	SDS	A1	7/16	1-1/16	1-5/16	5/8	8.3
6.3 †	4.56	5V632	SK	D1	9/32	7/16	1-7/8	3/32	10.7	5V633	SK	A1	11/32	1-1/16	1-7/8	5/32	11.2
6.7 †	4.94	5V672	SK	D1	9/32	7/16	1-7/8	3/32	11.0	5V673	SK	A1	11/32	1-1/16	1-7/8	5/32	13.8
7.1	5.31	5V712	SK	D1	9/32	7/16	1-7/8	3/32	13.4	5V713	SF	A1	5/16	1	2	1/16	14.8
7.5	5.62	5V752	SK	D1	9/32	7/16	1-7/8	3/32	14.0	5V753	SF	A1	5/16	1	2	1/16	16.6
8.0	6.12	5V802	SK	D1	9/32	7/16	1-7/8	3/32	15.9	5V803	SF	A1	5/16	1	2	1/16	18.7
8.5	6.62	5V852	SK	D2	9/32	7/16	1-7/8	3/32	14.2	5V853	SF	A1	5/16	1	2	1/16	21.0
9.0	7.12	5V902	SK	D2	9/32	7/16	1-7/8	3/32	16.4	5V903	SF	A1	5/16	1	2	1/16	23.3
9.25	7.44	5V9252	SK	D2	9/32	7/16	1-7/8	3/32	16.7	5V9253	SF	A2	5/16	1	2	1/16	20.4
9.75	7.94	5V9752	SK	D3	9/32	7/16	1-7/8	3/32	14.6	5V9753	SF	A2	5/16	1	2	1/16	22.7
10.3	8.50	5V1032	SK	D3	9/32	7/16	1-7/8	3/32	16.5	5V1033	SF	A2	5/16	1	2	1/16	26.1
10.9	9.12	5V1092	SK	D3	9/32	7/16	1-7/8	3/32	17.8	5V1093	SF	A2	5/16	1	2	1/16	26.7
11.3	9.38	5V1132	SK	D3	9/32	7/16	1-7/8	3/32	18.3	5V1133	SF	A3	5/16	1	2	1/16	25.7
11.8	9.94	5V1182	SK	D3	9/32	7/16	1-7/8	3/32	19.1	5V1183	SF	A3	5/16	1	2	1/16	26.7
12.5	10.62	5V1252	SF	C3	1/4	7/16	2	1/16	21.9	5V1253	E	C3	5/32	3/4	2-5/8	3/32	35.2
13.2	11.31	5V1322	SF	C3	1/4	7/16	2	1/16	24.7	5V1323	E	C3	5/32	3/4	2-5/8	3/32	37.1
14.0	12.12	5V1402	SF	C3	1/4	7/16	2	1/16	25.9	5V1403	E	C3	5/32	3/4	2-5/8	3/32	41.0
15.0	13.12	5V1502	SF	C3	1/4	7/16	2	1/16	27.7	5V1503	E	C3	5/32	3/4	2-5/8	3/32	42.6
16.0	14.12	5V1602	SF	C3	1/4	7/16	2	1/16	30.1	5V1603	E	C3	5/32	3/4	2-5/8	3/32	45.1
18.7	16.75	5V1872	SF	C3	1/4	7/16	2	1/16	40.0	5V1873	E	C3	5/32	3/4	2-5/8	3/32	54.4
21.2	19.25	5V2122	SF	C3	1/4	7/16	2	1/16	45.0	5V2123	E	C3	5/32	3/4	2-5/8	3/32	63.0
23.6	21.62	5V2362	E	C3	5/32	3/4	2-5/8	25/32	61.7	5V2363	E	C3	5/32	3/4	2-5/8	3/32	76.0
28.0	26.00	5V2802	E	C3	5/32	3/4	2-5/8	25/32	77.5	5V2803	E	C3	5/32	3/4	2-5/8	3/32	103.6
31.5	29.50	5V3153	F	C3	1/2	9/16	3-5/8	3/4	128.4
37.5	35.25	5V3753	F	C3	1/2	9/16	3-5/8	3/4	161.9
50.0	47.38	5V5003	F	C3	1/2	9/16	3-5/8	3/4	276.9

O.D. ◆	I.D.	Product No.	4 GROOVE F = 3-1/16							Product No.	5 GROOVE F = 3-3/4						
			Bush.	Type	E	K	L	M	Wt.		Bush.	Type	E	K	L	M	Wt.
4.4 †	2.70	5V444	SD	E1	1-7/8	0	1-13/16	5/8	6.4	5V445	SD	E1	2-9/16	0	1-13/16	5/8	7.3
4.65 †	2.94	5V4654	SD	E1	1-7/8	0	1-13/16	5/8	7.1	5V4655	SD	E1	2-9/16	0	1-13/16	5/8	8.1
4.9 †	3.25	5V494	SD	A1	11/16	1-5/16	1-13/16	9/16	7.7	5V495	SD	A1	11/16	1-5/16	1-13/16	1-1/4	8.7
5.2 †	3.50	5V524	SD	A1	11/16	1-5/16	1-13/16	9/16	8.7	5V525	SD	A1	11/16	1-5/16	1-13/16	1-1/4	9.9
5.5 †	3.75	5V554	SD	A1	11/16	1-5/16	1-13/16	9/16	9.8	5V555	SD	A1	11/16	1-5/16	1-13/16	1-1/4	11.1
5.9 †	4.18	5V594	SD	A1	11/16	1-5/16	1-13/16	9/16	11.1	5V595	SK	A1	19/32	1-5/16	1-7/8	1-9/32	12.6
6.3 †	4.56	5V634	SK	A1	19/32	1-5/16	1-7/8	19/32	12.7	5V635	SK	A1	19/32	1-5/16	1-7/8	1-9/32	14.3
6.7 †	4.94	5V674	SK	A1	19/32	1-5/16	1-7/8	19/32	14.3	5V675	SF	A1	5/8	1-5/16	2	1-1/8	16.6
7.1	5.31	5V714	SF	A1	3/8	1-1/16	2	11/16	16.6	5V715	SF	A1	11/16	1-3/8	2	1-1/16	19.9
7.5	5.62	5V754	SF	A1	3/8	1-1/16	2	11/16	18.7	5V755	SF	A1	11/16	1-3/8	2	1-1/16	20.8
8.0	6.12	5V804	E	B1	17/32	1-7/16	2-5/8	3/32	25.5	5V805	E	A1	27/32	1-3/4	2-5/8	9/32	27.8
8.5	6.62	5V854	E	B1	17/32	1-7/16	2-5/8	3/32	28.4	5V855	E	A1	27/32	1-3/4	2-5/8	9/32	30.8
9.0	7.12	5V904	E	B1	17/32	1-7/16	2-5/8	3/32	31.5	5V905	E	A1	27/32	1-3/4	2-5/8	9/32	34.1
9.25	7.44	5V9254	E	B1	17/32	1-7/16	2-5/8	3/32	32.8	5V9255	E	A1	27/32	1-3/4	2-5/8	9/32	35.4
9.75	7.94	5V9754	E	B2	17/32	1-7/16	2-5/8	3/32	38.0	5V9755	E	A2	27/32	1-3/4	2-5/8	9/32	38.8
10.3	8.50	5V1034	E	B2	17/32	1-7/16	2-5/8	3/32	33.9	5V1035	E	A2	27/32	1-3/4	2-5/8	9/32	37.3
10.9	9.12	5V1094	E	B2	17/32	1-7/16	2-5/8	3/32	36.0	5V1095	E	A2	27/32	1-3/4	2-5/8	9/32	39.5
11.3	9.38	5V1134	E	B2	17/32	1-7/16	2-5/8	3/32	40.0	5V1135	E	A2	27/32	1-3/4	2-5/8	9/32	43.6
11.8	9.94	5V1184	E	B2	17/32	1-7/16	2-5/8	3/32	42.7	5V1185	E	A2	27/32	1-3/4	2-5/8	9/32	45.4
12.5	10.62	5V1254	E	B3	17/32	1-7/16	2-5/8	3/32	42.5	5V1255	E	A3	27/32	1-3/4	2-5/8	9/32	44.4
13.2	11.31	5V1324	E	B3	17/32	1-7/16	2-5/8	3/32	45.0	5V1325	E	A3	27/32	1-3/4	2-5/8	9/32	46.8
14.0	12.12	5V1404	E	B3	17/32	1-7/16	2-5/8	3/32	47.0	5V1405	E	A3	27/32	1-3/4	2-5/8	9/32	52.0
15.0	13.12	5V1504	E	B3	17/32	1-7/16	2-5/8	3/32	47.7	5V1505	E	A3	27/32	1-3/4	2-5/8	9/32	53.9
16.0	14.12	5V1604	E	B3	17/32	1-7/16	2-5/8	3/32	51.0	5V1605	E	A3	27/32	1-3/4	2-5/8	9/32	57.4
18.7	16.75	5V1874	E	A3	11/32	1-1/4	2-5/8	3/32	63.0	5V1875	F	B3	1/4	1-5/16	3-5/8	1/8	86.9
21.2	19.25	5V2124	E	A3	11/32	1-1/4	2-5/8	3/32	75.0	5V2125	F	B3	1/4	1-5/16	3-5/8	1/8	97.3
23.6	21.62	5V2364	F	B3	3/16	7/8	3-5/8	3/8	98.2	5V2365	F	B3	1/4	1-5/16	3-5/8	1/8	111.9
28.0	26.00	5V2804	F	C3	3/16	7/8	3-5/8	3/8	125.5	5V2805	F	B3	1/4	1-5/16	3-5/8	1/8	143.1
31.5	29.50	5V3154	F	C3	3/16	7/8	3-5/8	3/8	141.6	5V3155	J	C3	1/4	1	4-1/2	1/2	174.6
37.5	35.25	5V3754	F	C3	3/16	7/8	3-5/8	3/8	192.2	5V3755	J	C3	1/4	1	4-1/2	1/2	237.5
50.0	47.38	5V5004	J	C3	9/16	11/16	4-1/2	7/8	306.0	5V5005	J	C3	1/4	1	4-1/2	1/2	344.6

◆ P.D. = O.D. † Recommended for use with 5VX Narrow Cog belts only.
Weights for all Sure-Grip bushed items are approximate and include the bushing.

STOCK NARROW (ULTRA-V) SHEAVES



DIMENSIONS (In Inches)

O.D. ◆	I.D.	Product No.	6 GROOVE							Product No.	7 GROOVE						
			F = 4-7/16								F = 5-1/8						
			Bush.	Type	E	K	L	M	Wt.		Bush.	Type	E	K	L	M	Wt.
4.4 †	2.70	5V446	SD	E1	3-1/4	0	1-13/16	5/8	8.3
4.65 †	2.94	5V4656	SD	E1	3-1/4	0	1-13/16	5/8	8.3
4.9 †	3.25	5V496	SD	A1	11/16	1-5/16	1-13/16	1-15/16	10.3
5.2 †	3.50	5V526	SD	A1	11/16	1-5/16	1-13/16	1-15/16	11.1
5.5 †	3.75	5V556	SD	A1	11/16	1-5/16	1-13/16	1-15/16	12.4
5.9 †	4.18	5V596	SK	A1	19/32	1-5/16	1-7/8	1-31/32	14.0
6.3 †	4.56	5V636	SK	A1	19/32	1-5/16	1-7/8	1-31/32	15.8
6.7 †	4.99	5V676	SF	A1	15/16	1-5/8	2	1-1/2	18.3
7.1	5.31	5V716	SF	A1	15/16	1-5/8	2	1-1/2	20.3	5V717	SF	A1	15/16	1-5/8	2	2-3/16	22.1
7.5	5.62	5V756	SF	A1	15/16	1-5/8	2	1-1/2	22.9	5V757	SF	A1	15/16	1-5/8	2	2-3/16	25.0
8.0	6.12	5V806	E	A1	1-3/32	2	2-5/8	23/32	30.1	5V807	E	A1	1-3/32	2	2-5/8	1-13/32	32.3
8.5	6.62	5V856	E	A1	1-3/32	2	2-5/8	23/32	30.3	5V857	E	A1	1-3/32	2	2-5/8	1-13/32	35.7
9.0	7.12	5V906	E	A1	1-3/32	2	2-5/8	23/32	36.7	5V907	E	A1	1-3/32	2	2-5/8	1-13/32	39.3
9.25	7.44	5V9256	E	A1	1-3/32	2	2-5/8	23/32	37.9	5V9257	E	A1	1-3/32	2	2-5/8	1-13/32	40.4
9.75	7.94	5V9756	E	A1	1-3/32	2	2-5/8	23/32	41.5	5V9757	E	A1	1-3/32	2	2-5/8	1-13/32	44.1
10.3	8.50	5V1036	E	A1	1-3/32	2	2-5/8	23/32	40.6	5V1037	F	B1	1-1/2	2-9/16	3-5/8	0	60.5
10.9	9.12	5V1096	E	A1	1-3/32	2	2-5/8	23/32	45.8	5V1097	F	B1	1-1/2	2-9/16	3-5/8	0	67.1
11.3	9.38	5V1136	E	A1	1-3/32	2	2-5/8	23/32	47.8	5V1137	F	B1	1-1/2	2-9/16	3-5/8	0	73.3
11.8	9.94	5V1186	E	A2	1-3/32	2	2-5/8	23/32	50.4	5V1187	F	B2	1-1/2	2-9/16	3-5/8	0	64.3
12.5	10.62	5V1256	F	B2	1	2-1/16	3-5/8	3/16	65.1	5V1257	F	B2	1-1/2	2-9/16	3-5/8	0	69.0
13.2	11.31	5V1326	F	B2	1	2-1/16	3-5/8	3/16	69.6	5V1327	F	B2	1-1/2	2-9/16	3-5/8	0	73.8
14.0	12.12	5V1406	F	B2	1	2-1/16	3-5/8	3/16	74.6	5V1407	F	B2	1-1/2	2-9/16	3-5/8	0	79.1
15.0	13.12	5V1506	F	B3	1	2-1/16	3-5/8	3/16	72.1	5V1507	F	B3	1-1/2	2-9/16	3-5/8	0	76.9
16.0	14.12	5V1606	F	B3	1	2-1/16	3-5/8	3/16	76.4	5V1607	F	B3	1-1/2	2-9/16	3-5/8	0	82.5
18.7	16.75	5V1876	F	A3	1/4	1-5/16	3-5/8	9/16	93.3	5V1877	F	A3	1/4	1-5/16	3-5/8	1-1/4	99.6
21.2	19.25	5V2126	F	A3	1/4	1-5/16	3-5/8	9/16	106.5	5V2127	J	A3	1/16	1-5/16	4-1/2	9/16	131.2
23.6	21.62	5V2366	J	B3	1/16	1-5/16	4-1/2	1/8	133.4	5V2367	J	A3	1/16	1-5/16	4-1/2	9/16	141.7
28.0	26.00	5V2806	J	B3	1/16	1-5/16	4-1/2	1/8	169.1	5V2807	J	A3	1/16	1-5/16	4-1/2	9/16	181.0
31.5	29.50	5V3156	J	B3	1/16	1-5/16	4-1/2	1/8	198.1	5V3157	J	A3	1/16	1-5/16	4-1/2	9/16	212.1
37.5	35.25	5V3756	J	B3	1/16	1-5/16	4-1/2	1/8	253.8	5V3757	M	B3	15/32	1-15/16	6-3/4	2-3/32	349.6
50.0	47.38	5V5006	M	C3	31/32	1/2	6-3/4	1-11/32	472.1	5V5007	M	C3	31/32	1/2	6-3/4	21/32	498.1

◆ P.D. = O.D. † Recommended for use with 5VX Narrow Cog belts only.
Weights for all Sure-Grip bushed items are approximate and include the bushing.

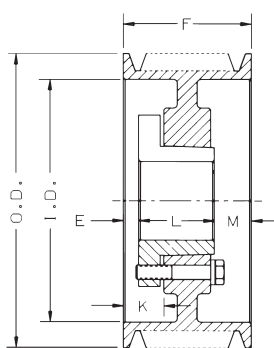

Type A

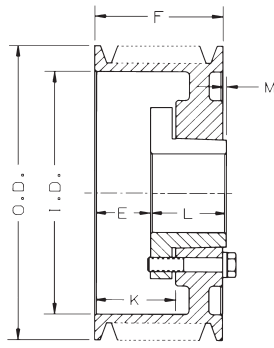

Type B

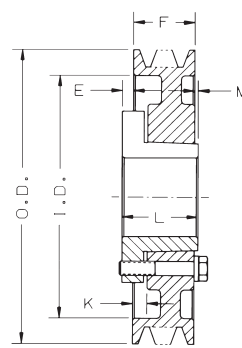

Type C

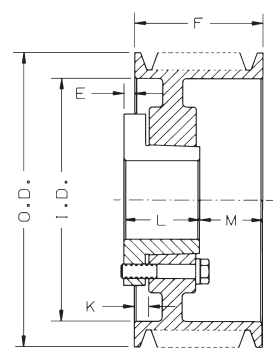

Type D

DIMENSIONS (In Inches)

O.D. ◆	I.D.	Product No.	8 GROOVE F = 5-13/16							Product No.	9 GROOVE F = 6-1/2						
			Bush.	Type	E	K	L	M	Wt.		Bush.	Type	E	K	L	M	Wt.
7.1	5.31	5V718	SF	A1	1-7/16	2-1/8	2	2-3/8	24.0
7.5	5.62	5V758	SF	A1	1-7/16	2-1/8	2	2-3/8	27.1
8.0	6.12	5V808	E	A1	1-19/32	2-1/2	2-5/8	1-19/32	34.6	5V809	E	A1	1-19/32	2-1/2	2-5/8	2-9/32	36.9
8.5	6.62	5V858	E	A1	1-19/32	2-1/2	2-5/8	1-19/32	38.2	5V859	E	A1	1-19/32	2-1/2	2-5/8	2-9/32	40.6
9.0	7.12	5V908	E	A1	1-19/32	2-1/2	2-5/8	1-19/32	41.9	5V909	E	A1	1-19/32	2-1/2	2-5/8	2-9/32	44.5
9.25	7.44	5V9258	F	A1	1-1/2	2-9/16	3-5/8	11/16	51.7	5V9259	F	A1	1-1/2	2-9/16	3-5/8	1-3/8	54.2
9.75	7.94	5V9758	F	A1	1-1/2	2-9/16	3-5/8	11/16	57.0	5V9759	F	A1	1-1/2	2-9/16	3-5/8	1-3/8	59.7
10.3	8.50	5V1038	F	A1	1-1/2	2-9/16	3-5/8	11/16	63.4	5V1039	F	A1	1-1/2	2-9/16	3-5/8	1-3/8	66.3
10.9	9.12	5V1098	F	A1	1-1/2	2-9/16	3-5/8	11/16	70.2	5V1099	F	A1	1-1/2	2-9/16	3-5/8	1-3/8	73.3
11.3	9.38	5V1138	F	A1	1-1/2	2-9/16	3-5/8	11/16	76.9	5V1139	F	A1	1-1/2	2-9/16	3-5/8	1-3/8	80.5
11.8	9.94	5V1188	F	A2	1-1/2	2-9/16	3-5/8	11/16	67.9	5V1189	F	A2	1-1/2	2-9/16	3-5/8	1-3/8	71.4
12.5	10.62	5V1258	F	A2	1-1/2	2-9/16	3-5/8	11/16	72.8	5V1259	F	A2	1-1/2	2-9/16	3-5/8	1-3/8	76.8
13.2	11.31	5V1328	F	A2	1-1/2	2-9/16	3-5/8	11/16	77.9	5V1329	F	A2	1-1/2	2-9/16	3-5/8	1-3/8	83.9
14.0	12.12	5V1408	F	A2	1-1/2	2-9/16	3-5/8	11/16	83.3	5V1409	F	A2	1-1/2	2-9/16	3-5/8	1-3/8	90.2
15.0	13.12	5V1508	F	A3	1-1/2	2-9/16	3-5/8	11/16	81.5	5V1509	J	B2	2-5/16	3-9/16	4-1/2	5/16	109.5
16.0	14.12	5V1608	F	A3	1-1/2	2-9/16	3-5/8	11/16	87.4	5V1609	J	B3	2-5/16	3-9/16	4-1/2	5/16	109.0
18.7	16.75	5V1878	J	A3	5/16	1-9/16	4-1/2	1	124.6	5V1879	J	A3	5/16	1-9/16	4-1/2	1-11/16	128.6
21.2	19.25	5V2128	J	A3	5/16	1-9/16	4-1/2	1	138.9	5V2129	J	A3	5/16	1-9/16	4-1/2	1-11/16	146.0
23.6	21.62	5V2368	J	A3	5/16	1-9/16	4-1/2	1	154.6	5V2369	J	A3	5/16	1-9/16	4-1/2	1-11/16	165.1
28.0	26.00	5V2808	J	A3	5/16	1-9/16	4-1/2	1	191.0	5V2809	M	B3	15/32	1-15/16	6-3/4	23/32	273.7
31.5	29.50	5V3158	M	B3	15/32	1-15/16	6-3/4	1-13/32	295.7	5V3159	M	B3	15/32	1-15/16	6-3/4	23/32	316.0
37.5	35.25	5V3758	M	B3	15/32	1-15/16	6-3/4	1-13/32	366.2	5V3759	M	B3	15/32	1-15/16	6-3/4	23/32	398.5
50.0	47.38	5V5008	M	B3	15/32	1-15/16	6-3/4	1-13/32	540.0	5V5009	M	B3	15/32	1-15/16	6-3/4	23/32	580.1

O.D. ◆	I.D.	Product No.	10 GROOVE F = 7-3/16						
			Bush.	Type	E	K	L	M	Wt.
8.0	6.12	5V8010	E	A1	2-11/32	3-1/4	2-5/8	2-7/32	39.1
8.5	6.62	5V8510	E	A1	2-11/32	3-1/4	2-5/8	2-7/32	43.0
9.0	7.12	5V9010	F	A1	2-1/4	3-5/16	3-5/8	1-5/16	54.9
9.25	7.38	5V92510	F	A1	2-1/4	3-5/16	3-5/8	1-5/16	59.1
9.75	7.94	5V97510	F	A1	2-1/4	3-5/16	3-5/8	1-5/16	62.4
10.3	8.50	5V10310	F	A1	2-1/4	3-5/16	3-5/8	1-5/16	69.2
10.9	9.12	5V10910	F	A1	2-1/4	3-5/16	3-5/8	1-5/16	76.3
11.3	9.38	5V11310	F	A1	2-1/4	3-5/16	3-5/8	1-5/16	84.0
11.8	9.94	5V11810	F	A2	2-1/4	3-5/16	3-5/8	1-5/16	75.0
12.5	10.62	5V12510	J	A2	2-5/16	3-9/16	4-1/2	3/8	92.9
13.2	11.31	5V13210	J	A2	2-5/16	3-9/16	4-1/2	3/8	99.0
14.0	12.12	5V14010	J	A2	2-5/16	3-9/16	4-1/2	3/8	105.4
15.0	13.12	5V15010	J	A2	2-5/16	3-9/16	4-1/2	3/8	99.0
16.0	14.12	5V16010	J	A3	2-5/16	3-9/16	4-1/2	3/8	114.1
18.7	16.75	5V18710	J	A3	5/16	1-9/16	4-1/2	2-3/8	136.4
21.2	19.25	5V21210	J	A3	5/16	1-9/16	4-1/2	2-3/8	159.4
23.6	21.62	5V23610	M	B3	15/32	1-15/16	6-3/4	1/32	245.8
28.0	26.00	5V28010	M	B3	15/32	1-15/16	6-3/4	1/32	293.0
31.5	29.50	5V31510	M	B3	15/32	1-15/16	6-3/4	1/32	329.1
37.5	35.25	5V37510	M	B3	15/32	1-15/16	6-3/4	1/32	421.0
50.0	47.38	5V50010	M	B3	15/32	1-15/16	6-3/4	1/32	637.1

◆ P.D. = O.D.

Weights for all Sure-Grip bushed items are approximate and include the bushing.

STOCK NARROW (ULTRA-V) SHEAVES



These sheaves are designed to carry the loads of all belts shown in this catalog and other similarly rated V-Belts. For special higher rated V-Belts, consult Wood's Engineering Department for recommendations.

The sheaves listed below are all stock sizes. The dimensions given are with the Sure-Grip bushings in place. When ordering, specify the bushing, if required, and the bore size. The figure following the letter in the "Type" column indicates the sheave construction: 1 – Solid, 2 – Web, 3 – Arms.

DIMENSIONS (In Inches)

O.D. ◆	I.D.	Product No.	4 GROOVE							Product No.	5 GROOVE						
			F = 4-7/8								F = 6						
			Bush.	Type	E	K	L	M	Wt.		Bush.	Type	E	K	L	M	Wt.
12.5	9.75	8V1254	F	A1	1/8	1-3/16	3-5/8	1-1/8	85.5	8V1255	F	A1	1-1/4	2-5/16	3-5/8	1-1/8	93.3
13.2	10.44	8V1324	F	A2	1/8	1-3/16	3-5/8	1-1/8	78.4	8V1325	F	A2	1-1/4	2-5/16	3-5/8	1-1/8	88.2
14.0	11.25	8V1404	F	A2	1/8	1-3/16	3-5/8	1-1/8	84.5	8V1405	F	A2	1-1/4	2-5/16	3-5/8	1-1/8	95.2
15.0	12.25	8V1504	F	A2	1/8	1-3/16	3-5/8	1-1/8	92.6	8V1505	F	A2	1-1/4	2-5/16	3-5/8	1-1/8	108.0
16.0	13.25	8V1604	F	A2	1/8	1-3/16	3-5/8	1-1/8	98.8	8V1605	F	A2	1-1/4	2-5/16	3-5/8	1-1/8	112.1
17.0	14.25	8V1704	F	A2	1/8	1-3/16	3-5/8	1-1/8	109.4	8V1705	J	A2	3/4	2	4-1/2	3/4	141.0
18.0	15.25	8V1804	F	A2	1/8	1-3/16	3-5/8	1-1/8	118.1	8V1805	J	A2	3/4	2	4-1/2	3/4	157.0
19.0	16.25	8V1904	F	A2	1/8	1-3/16	3-5/8	1-1/8	128.3	8V1905	J	A2	3/4	2	4-1/2	3/4	169.0
20.0	17.25	8V2004	J	A3	3/16	1-7/16	4-1/2	3/16	128.3	8V2005	J	A2	3/4	2	4-1/2	3/4	167.5
21.2	18.44	8V2124	J	A3	3/16	1-7/16	4-1/2	3/16	142.8	8V2125	J	A2	3/4	2	4-1/2	3/4	183.8
22.4	19.62	8V2244	J	A3	3/16	1-7/16	4-1/2	3/16	154.2	8V2245	M	B2	15/32	1-15/16	6-3/4	1-7/32	262.0
24.8	21.90	8V2484	M	C3	21/32	13/16	6-3/4	1-7/32	247.5	8V2485	M	B3	15/32	1-15/16	6-3/4	1-7/32	266.5
30.0	27.12	8V3004	M	C3	21/32	13/16	6-3/4	1-7/32	286.7	8V3005	M	B3	15/32	1-15/16	6-3/4	1-7/32	327.6
35.5	32.50	8V3554	M	C3	21/32	13/16	6-3/4	1-7/32	342.0	8V3555	M	B3	15/32	1-15/16	6-3/4	1-7/32	404.0
40.0	37.00	8V4004	M	C3	21/32	13/16	6-3/4	1-7/32	407.6	8V4005	M	B3	15/32	1-15/16	6-3/4	1-7/32	441.0
44.5	41.60	8V4454	M	C3	21/32	13/16	6-3/4	1-7/32	461.0	8V4455	N	C3	3/4	15/16	8-1/8	1-3/8	580.5
53.0	49.81	8V5304	M	C3	21/32	13/16	6-3/4	1-7/32	557.0	8V5305	N	C3	3/4	15/16	8-1/8	1-3/8	688.0

◆ P.D. = O.D.

Weights for all Sure-Grip bushed items are approximate and include the bushing.

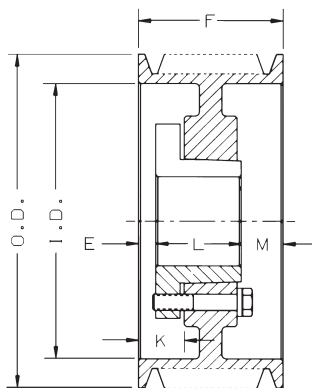

Type A

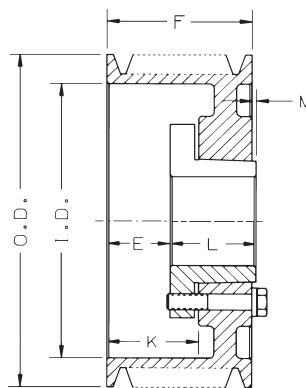

Type B

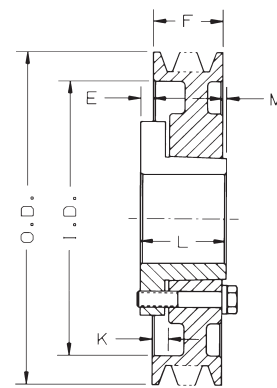

Type C

DIMENSIONS (In Inches)

O.D. ◆	I.D.	Product No.	6 GROOVE							Product No.	8 GROOVE						
			F = 7-1/8								F = 9-3/8						
			Bush.	Type	E	K	L	M	Wt.		Bush.	Type	E	K	L	M	Wt.
12.5	9.75	8V1256	F	A1	1-1/4	2-5/16	3-5/8	2-1/4	100.9	8V1258	J	A1	2-5/16	3-9/16	4-1/2	2-9/16	129.1
13.2	10.44	8V1326	F	A2	1-1/4	2-5/16	3-5/8	2-1/4	96.6	8V1328	J	A1	2-5/16	3-9/16	4-1/2	2-9/16	144.5
14.0	11.25	8V1406	F	A2	1-1/4	2-5/16	3-5/8	2-1/4	104.1	8V1408	J	A2	2-5/16	3-9/16	4-1/2	2-9/16	136.6
15.0	12.25	8V1506	J	A2	1-5/16	2-9/16	4-1/2	1-5/16	133.0	8V1508	J	A2	2-5/16	3-9/16	4-1/2	2-9/16	146.5
16.0	13.25	8V1606	J	A2	1-5/16	2-9/16	4-1/2	1-5/16	143.5	8V1608	J	A2	2-5/16	3-9/16	4-1/2	2-9/16	164.5
17.0	14.25	8V1706	J	A2	1-5/16	2-9/16	4-1/2	1-5/16	153.0	8V1708	M	A2	2-15/32	3-15/16	6-3/4	5/32	244.1
18.0	15.25	8V1806	J	A2	1-5/16	2-9/16	4-1/2	1-5/16	169.0	8V1808	M	A2	2-15/32	3-15/16	6-3/4	5/32	257.0
19.0	16.25	8V1906	J	A2	1-5/16	2-9/16	4-1/2	1-5/16	182.0	8V1908	M	A2	2-15/32	3-15/16	6-3/4	5/32	280.0
20.0	17.25	8V2006	M	B2	1-15/32	2-15/16	6-3/4	1-3/32	242.8	8V2008	M	A2	2-15/32	3-15/16	6-3/4	5/32	292.6
21.2	18.44	8V2126	M	B2	1-15/32	2-15/16	6-3/4	1-3/32	263.3	8V2128	M	A2	2-15/32	3-15/16	6-3/4	5/32	314.0
22.4	19.62	8V2246	M	B2	1-15/32	2-15/16	6-3/4	1-3/32	280.9	8V2248	M	A2	2-15/32	3-15/16	6-3/4	5/32	338.0
24.8	21.90	8V2486	M	B3	15/32	1-15/16	6-3/4	3/32	285.5	8V2488	N	A3	9/16	2-1/4	8-1/8	11/16	377.0
30.0	27.12	8V3006	M	B3	15/32	1-15/16	6-3/4	3/32	354.4	8V3008	N	A3	9/16	2-1/4	8-1/8	11/16	468.9
35.5	32.50	8V3556	N	C3	9/16	1-1/8	8-1/8	7/16	537.0	8V3558	N	A3	9/16	2-1/4	8-1/8	11/16	588.0
40.0	37.00	8V4006	N	C3	9/16	1-1/8	8-1/8	7/16	549.9	8V4008	N	A3	9/16	2-1/4	8-1/8	11/16	663.0
44.5	41.60	8V4456	N	C3	9/16	1-1/8	8-1/8	7/16	619.5	8V4458	P	B3	3/4	2-5/8	9-3/8	3/4	860.0
53.0	49.81	8V5306	N	C3	9/16	1-1/8	8-1/8	7/16	768.0	8V5308	P	B3	3/4	2-5/8	9-3/8	3/4	992.0
63.0	59.69	8V6306	P	B3	1/8	2	9-3/8	2-3/8	1027.0	8V6308	P	B3	3/4	2-5/8	9-3/8	3/4	1262.0
71.0	67.70	8V7106	P	B3	1/8	2	9-3/8	2-3/8	1200.0	8V7108	W	B3	0	2-1/4	11-3/8	2	1725.0

O.D. ◆	I.D.	Product No.	10 GROOVE							Product No.	12 GROOVE						
			F = 11-5/8								F = 13-7/8						
			Bush.	Type	E	K	L	M	Wt.		Bush.	Type	E	K	L	M	Wt.
12.5	9.75	8V12510	J	A1	2-5/16	3-9/16	4-1/2	4-13/16	148.9	8V12512	M	A1	2-15/32	3-15/16	6-3/4	4-21/32	198.0
13.2	10.44	8V13210	J	A1	2-5/16	3-9/16	4-1/2	4-13/16	148.6	8V13212	M	A1	2-15/32	3-15/16	6-3/4	4-21/32	225.0
14.0	11.25	8V14010	J	A2	2-5/16	3-9/16	4-1/2	4-13/16	161.0	8V14012	M	A1	2-15/32	3-15/16	6-3/4	4-21/32	245.8
15.0	12.25	8V15010	M	A1	2-15/32	3-15/16	6-3/4	2-13/32	264.0	8V15012	M	A1	2-15/32	3-15/16	6-3/4	4-21/32	285.0
16.0	13.25	8V16010	M	A2	2-15/32	3-15/16	6-3/4	2-13/32	296.7	8V16012	M	A1	2-15/32	3-15/16	6-3/4	4-21/32	324.0
17.0	14.25	8V17010	M	A2	2-15/32	3-15/16	6-3/4	2-13/32	269.1	8V17012	M	A2	2-15/32	3-15/16	6-3/4	4-21/32	324.0
18.0	15.25	8V18010	M	A2	2-15/32	3-15/16	6-3/4	2-13/32	295.0	8V18012	M	A2	2-15/32	3-15/16	6-3/4	4-21/32	338.0
19.0	16.25	8V19010	M	A2	2-15/32	3-15/16	6-3/4	2-13/32	318.0	8V19012	N	A2	9/16	2-1/4	8-1/8	5-3/16	412.0
20.0	17.25	8V20010	M	A2	2-15/32	3-15/16	6-3/4	2-13/32	318.6	8V20012	N	A2	9/16	2-1/4	8-1/8	5-3/16	411.0
21.2	18.44	8V21210	M	A2	2-15/32	3-15/16	6-3/4	2-13/32	340.7	8V21212	N	A2	9/16	2-1/4	8-1/8	5-3/16	421.0
22.4	19.62	8V22410	N	A2	9/16	2-1/4	8-1/8	2-15/16	411.1	8V22412	N	A2	9/16	2-1/4	8-1/8	5-3/16	478.0
24.8	21.90	8V24810	N	A2	9/16	2-1/4	8-1/8	2-15/16	463.0	8V24812	N	A2	9/16	2-1/4	8-1/8	5-3/16	516.5
30.0	27.12	8V30010	N	A3	9/16	2-1/4	8-1/8	2-15/16	557.5	8V30012	P	A3	3/4	2-5/8	9-3/8	3-3/4	672.1
35.5	32.50	8V35510	P	A3	3/4	2-5/8	9-3/8	1-1/2	727.0	8V35512	P	A3	3/4	2-5/8	9-3/8	3-3/4	837.0
40.0	37.00	8V40010	P	A3	3/4	2-5/8	9-3/8	1-1/2	817.9	8V40012	P	A3	3/4	2-5/8	9-3/8	3-3/4	909.5
44.5	41.60	8V44510	P	A3	3/4	2-5/8	9-3/8	1-1/2	927.0	8V44512	P	A3	3/4	2-5/8	9-3/8	3-3/4	1097.0
53.0	49.81	8V53010	P	A3	3/4	2-5/8	9-3/8	1-1/2	1137.0	8V53012	W	A3	5/8	2-7/8	11-3/8	1-7/8	1482.0
63.0	59.69	8V63010	W	B3	3/8	2-5/8	11-3/8	1/8	1652.0	8V63012	W	A3	5/8	2-7/8	11-3/8	1-7/8	1777.0
71.0	67.70	8V71010	W	B3	3/8	2-5/8	11-3/8	1/8	1865.0	8V71012	W	A3	5/8	2-7/8	11-3/8	1-7/8	2180.0

◆ P.D. = O.D.

Weights for all Sure-Grip bushed items are approximate and include the bushing.

NARROW (ULTRA-V) V-BELT FEATURES



The three cross sections of Wood's Narrow (Ultra-V) belts transmit more horsepower than the five sizes of the Classical (Conventional) V-belt. The narrower geometry of the belt results in cross sections that are up to 50% smaller than the Classical (Conventional) cross sections. This allows the use of smaller diameter sheaves resulting in more compact, lighter weight drives that can operate at higher speeds, reduce bearing loads, and shaft stresses. All Wood's Narrow (Ultra-V) belts are static conducting, and oil and heat resistant.

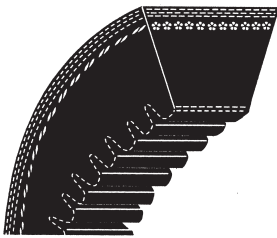
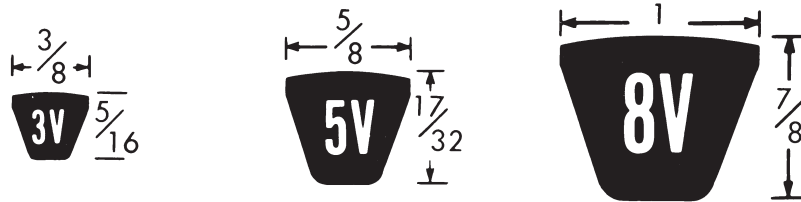

Narrow (Ultra-V) Cog V-belts . . . a premium raw edge, cog construction at no extra cost. Up to 30% more horsepower capacity than wrapped belts. The molded cogs offer greater flexibility and better heat dissipation, especially important on drives using smaller diameter sheaves and short center distances. Stock in all 3V lengths, 5V and 8V lengths up to 200 inches.

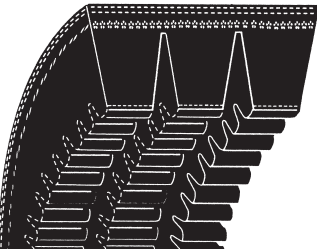

Narrow (Ultra-V) Cog Banded V-belts . . . all the same features of the individual Narrow (Ultra-V) Cog belt, but with the added benefit of multiple belts in a single belt. Should be considered for those problem drives where long center distance, vibration, pulsating or shock loads cause individual belts to whip, turn over, or jump out of sheave grooves. Stock in all 3V and 5V, 2 thru 5 ribs in lengths up to 200 inches.

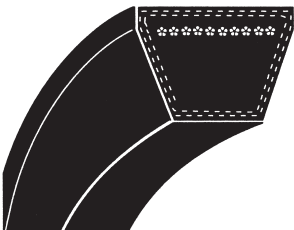

Narrow (Ultra-V) V-belts . . . wrapped construction of 5V and 8V belts over 200 inches long. Handles applications that require longer length belts or larger cross sections where flexibility and compactness are not as critical.

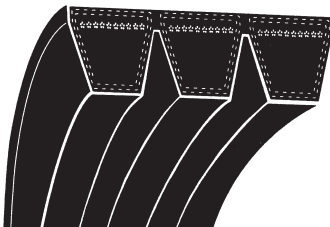

Narrow (Ultra-V) Banded V-belts . . . wrapped construction of 5V belts over 200 inches and all 8V section belts. Can be used on those same problem drives as the Narrow (Ultra-V) Cog Banded belts. Stocked in 2 thru 5 ribs (5V section) and 3 thru 5 ribs (8V section).

Warning: Do not mix raw edge cog and wrapped construction belts on the same drive.



NARROW (ULTRA-V) BELTS AND NARROW (ULTRA-V) BANDED V-BELTS

Wood's Narrow belts listed here are described in detail on page B1—13 and are available from stock in all sizes.

3VX Belts			5V Belts			5VX Belts (cont.)			8V and 8VX Belts		
Product No.	Belt Length	Wt.	Product No.	Belt Length	Wt.	Product No.	Belt Length	Wt.	Product No.	Belt Length	Wt.
3VX250	25.0	.1	5V2120	212.0	2.5	5VX710	71.0	.8	8VX1000	100.0	3.5
3VX265	26.5	.1	5V2240	224.0	2.7	5VX730	73.0	.8	8VX1060	106.0	3.7
3VX280	28.0	.1	5V2360	236.0	2.8	5VX740	74.0	.8	8VX1120	112.0	3.9
3VX300	30.0	.1	5V2500	250.0	3.0	5VX750	75.0	.8	8VX1180	118.0	4.2
3VX315	31.5	.1	5V2650	265.0	3.2	5VX780	78.0	.9	8VX1250	125.0	4.4
3VX335	33.5	.2	5V2800	280.0	3.3	5VX800	80.0	.9	8VX1320	132.0	4.6
3VX355	35.5	.2	5V3000	300.0	3.6	5VX810	81.0	.9	8VX1400	140.0	4.9
3VX375	37.5	.2	5V3150	315.0	3.8	5VX830	83.0	.9	8VX1500	150.0	5.3
3VX400	40.0	.2	5V3350	335.0	4.1	5VX840	84.0	.9	8VX1600	160.0	5.6
3VX425	42.5	.2	5V3550	355.0	4.3	5VX850	85.0	.9	8VX1700	170.0	6.0
3VX450	45.0	.2	5VX Belts			5VX860	86.0	1.0	8VX1800	180.0	6.3
3VX475	47.5	.2				5VX880	88.0	1.0	8VX1900	190.0	6.7
3VX500	50.0	.2	Product No.	Belt Length	Wt.	5VX900	90.0	1.1	8VX2000	200.0	7.0
3VX530	53.0	.2	5VX450	45.0	.5	5VX930	93.0	1.1	8V2120	212.0	7.5
3VX560	56.0	.2	5VX470	47.0	.5	5VX950	95.0	1.1	8V2240	224.0	7.9
3VX600	60.0	.3	5VX490	49.0	.6	5VX960	96.0	1.1	8V2360	236.0	8.3
3VX630	63.0	.3	5VX500	50.0	.6	5VX1000	100.0	1.2	8V2500	250.0	8.8
3VX650	65.0	.3	5VX510	51.0	.6	5VX1030	103.0	1.2	8V2650	265.0	9.3
3VX670	67.0	.3	5VX530	53.0	.7	5VX1060	106.0	1.2	8V2800	280.0	9.8
3VX710	71.0	.3	5VX540	54.0	.7	5VX1080	108.0	1.2	8V3000	300.0	10.5
3VX750	75.0	.3	5VX550	55.0	.7	5VX1120	112.0	1.3	8V3150	315.0	11.1
3VX800	80.0	.4	5VX560	56.0	.7	5VX1150	115.0	1.3	8V3350	335.0	11.8
3VX850	85.0	.4	5VX570	57.0	.7	5VX1160	116.0	1.4	8V3500	355.0	12.5
3VX900	90.0	.4	5VX580	58.0	.7	5VX1180	118.0	1.4	8V3750	375.0	13.7
3VX950	95.0	.4	5VX590	59.0	.7	5VX1230	123.0	1.4	8V4000	400.0	14.0
3VX1000	100.0	.4	5VX600	60.0	.7	5VX1250	125.0	1.5	8V4250	425.0	14.9
3VX1060	106.0	.5	5VX610	61.0	.7	5VX1320	132.0	1.6	8V4500	450.0	15.8
3VX1120	112.0	.5	5VX630	63.0	.7	5VX1400	140.0	1.7	8V4750	475.0	16.7
3VX1180	118.0	.6	5VX650	65.0	.8	5VX1500	150.0	1.8	8V5000	500.0	17.6
3VX1250	125.0	.6	5VX660	66.0	.8	5VX1600	160.0	1.9			
3VX1320	132.0	.7	5VX670	67.0	.8	5VX1700	170.0	2.0			
3VX1400	140.0	.7	5VX680	68.0	.8	5VX1800	180.0	2.1			
3VX1500	150.0	.7	5VX690	69.0	.8	5VX1900	190.0	2.3			
						5VX2000	200.0	2.4			

3VX NARROW (Ultra-V) BANDED V-BELTS

Product No.	Belt Length	Wt. Lbs.	Product No.	Belt Length	Wt. Lbs.	Product No.	Belt Length	Wt. Lbs.	Product No.	Belt Length	Wt. Lbs.	Product No.	Belt Length	Wt. Lbs.
2R3VX250	25.0	.2	4R3VX355	35.5	.6	2R3VX530	53.0	.5	4R3VX750	75.0	1.4	2R3VX1120	112.0	1.0
3R3VX250	25.0	.3	5R3VX355	35.5	.8	3R3VX530	53.0	.7	5R3VX750	75.0	1.7	3R3VX1120	112.0	1.5
4R3VX250	25.0	.4	2R3VX375	37.5	.3	4R3VX530	53.0	1.0	2R3VX800	80.0	.7	4R3VX1120	112.0	2.0
5R3VX250	25.0	.5	3R3VX375	37.5	.5	5R3VX530	53.0	1.2	3R3VX800	80.0	1.1	5R3VX1120	112.0	2.5
2R3VX265	26.5	.2	4R3VX375	37.5	.6	2R3VX560	56.0	.5	4R3VX800	80.0	1.4	2R3VX1180	118.0	1.1
3R3VX265	26.5	.4	5R3VX375	37.5	.8	3R3VX560	56.0	.8	5R3VX800	80.0	1.8	3R3VX1180	118.0	1.6
4R3VX265	26.5	.5	2R3VX400	40.0	.4	4R3VX560	56.0	1.0	2R3VX850	85.0	.8	4R3VX1180	118.0	2.1
5R3VX265	26.5	.6	3R3VX400	40.0	.5	5R3VX560	56.0	1.3	3R3VX850	85.0	1.2	5R3VX1180	118.0	2.7
2R3VX280	28.0	.2	4R3VX400	40.0	.8	2R3VX600	60.0	.5	4R3VX850	85.0	1.5	2R3VX1250	125.0	1.1
3R3VX280	28.0	.4	5R3VX400	40.0	.9	3R3VX600	60.0	.8	5R3VX850	85.0	1.9	3R3VX1250	125.0	1.7
4R3VX280	28.0	.5	2R3VX425	42.5	.4	4R3VX600	60.0	1.1	2R3VX900	90.0	.8	4R3VX1250	125.0	2.3
5R3VX280	28.0	.6	3R3VX425	42.5	.6	5R3VX600	60.0	1.4	3R3VX900	90.0	1.2	5R3VX1250	125.0	2.8
2R3VX300	30.0	.3	4R3VX425	42.5	.8	2R3VX630	63.0	.6	4R3VX900	90.0	1.6	2R3VX1320	132.0	1.2
3R3VX300	30.0	.4	5R3VX425	42.5	1.0	3R3VX630	63.0	.9	5R3VX900	90.0	2.0	3R3VX1320	132.0	1.8
4R3VX300	30.0	.6	2R3VX450	45.0	.4	4R3VX630	63.0	1.1	2R3VX950	95.0	.9	4R3VX1320	132.0	2.4
5R3VX300	30.0	.8	3R3VX450	45.0	.6	5R3VX630	63.0	1.4	3R3VX950	95.0	1.3	5R3VX1320	132.0	3.0
2R3VX315	31.5	.3	4R3VX450	45.0	.8	2R3VX670	67.0	.6	4R3VX950	95.0	1.7	2R3VX1400	140.0	1.3
3R3VX315	31.5	.4	5R3VX450	45.0	1.0	3R3VX670	67.0	.9	5R3VX950	95.0	2.2	3R3VX1400	140.0	1.9
4R3VX315	31.5	.6	2R3VX475	47.5	.4	4R3VX670	67.0	1.2	2R3VX1000	100.0	.9	4R3VX1400	140.0	2.5
5R3VX315	31.5	.8	3R3VX475	47.5	.6	5R3VX670	67.0	1.5	3R3VX1000	100.0	1.4	5R3VX1400	140.0	3.2
2R3VX335	33.5	.3	4R3VX475	47.5	.9	2R3VX710	71.0	.6	4R3VX1000	100.0	1.8			
3R3VX335	33.5	.4	5R3VX475	47.5	1.1	3R3VX710	71.0	1.0	5R3VX1000	100.0	2.3			
4R3VX335	33.5	.6	2R3VX500	50.0	.4	4R3VX710	71.0	1.3	2R3VX1060	106.0	1.0			
5R3VX335	33.5	.8	3R3VX500	50.0	.7	5R3VX710	71.0	1.6	3R3VX1060	106.0	1.4			
2R3VX355	35.5	.3	4R3VX500	50.0	.9	2R3VX750	75.0	.7	4R3VX1060	106.0	1.9			
3R3VX355	35.5	.5	5R3VX500	50.0	1.1	3R3VX750	75.0	1.0	5R3VX1060	106.0	2.4			

NARROW (ULTRA-V) BANDED V-BELTS



5VX NARROW (Ultra-V) BANDED V-BELTS

Product No.	Belt Length	Wt. Lbs.	Product No.	Belt Length	Wt. Lbs.	Product No.	Belt Length	Wt. Lbs.	Product No.	Belt Length	Wt. Lbs.	Product No.	Belt Length	Wt. Lbs.
2R5VX500	50.0	1.3	2R5VX750	75.0	1.9	2R5VX1120	112.0	2.9	2R5VX1700	170.0	4.4	2R5V2500	250.0	6.4
3R5VX500	50.0	1.9	3R5VX750	75.0	2.9	3R5VX1120	112.0	4.3	3R5VX1700	170.0	6.6	3R5V2500	250.0	9.7
4R5VX500	50.0	2.6	4R5VX750	75.0	3.8	4R5VX1120	112.0	5.7	4R5VX1700	170.0	8.7	4R5V2500	250.0	12.9
5R5VX500	50.0	3.3	5R5VX750	75.0	4.8	5R5VX1120	112.0	7.2	5R5VX1700	170.0	10.9	5R5V2500	250.0	16.1
2R5VX530	53.0	1.3	2R5VX800	80.0	2.0	2R5VX1180	118.0	3.0	2R5VX1800	180.0	4.6	2R5V2650	265.0	6.8
3R5VX530	53.0	2.0	3R5VX800	80.0	3.1	3R5VX1180	118.0	4.5	3R5VX1800	180.0	6.9	3R5V2650	265.0	10.3
4R5VX530	53.0	2.7	4R5VX800	80.0	4.1	4R5VX1180	118.0	6.0	4R5VX1800	180.0	9.3	4R5V2650	265.0	13.7
5R5VX530	53.0	3.4	5R5VX800	80.0	5.1	5R5VX1180	118.0	7.6	5R5VX1800	180.0	11.6	5R5V2650	265.0	17.1
2R5VX560	56.0	1.4	2R5VX850	85.0	2.2	2R5VX1250	125.0	3.2	2R5VX1900	190.0	4.9	2R5V2800	280.0	7.2
3R5VX560	56.0	2.1	3R5VX850	85.0	3.2	3R5VX1250	125.0	4.8	3R5VX1900	190.0	7.3	3R5V2800	280.0	10.8
4R5VX560	56.0	2.8	4R5VX850	85.0	4.3	4R5VX1250	125.0	6.4	4R5VX1900	190.0	9.8	4R5V2800	280.0	14.5
5R5VX560	56.0	3.5	5R5VX850	85.0	5.4	5R5VX1250	125.0	8.0	5R5VX1900	190.0	12.2	5R5V2800	280.0	18.1
2R5VX600	60.0	1.5	2R5VX900	90.0	2.3	2R5VX1320	132.0	3.4	2R5VX2000	200.0	5.1	2R5V3000	300.0	7.7
3R5VX600	60.0	2.3	3R5VX900	90.0	3.4	3R5VX1320	132.0	5.1	3R5VX2000	200.0	7.7	3R5V3000	300.0	11.6
4R5VX600	60.0	3.0	4R5VX900	90.0	4.6	4R5VX1320	132.0	6.8	4R5VX2000	200.0	10.3	4R5V3000	300.0	15.5
5R5VX600	60.0	3.8	5R5VX900	90.0	5.7	5R5VX1320	132.0	8.5	5R5VX2000	200.0	12.9	5R5V3000	300.0	19.4
2R5VX630	63.0	1.6	2R5VX950	95.0	2.4	2R5VX1400	140.0	3.6	2R5V2120	212.0	5.5	2R5V3150	315.0	8.1
3R5VX630	63.0	2.4	3R5VX950	95.0	3.6	3R5VX1400	140.0	5.4	3R5V2120	212.0	8.2	3R5V3150	315.0	12.2
4R5VX630	63.0	3.2	4R5VX950	95.0	4.8	4R5VX1400	140.0	7.2	4R5V2120	212.0	10.9	4R5V3150	315.0	16.3
5R5VX630	63.0	4.0	5R5VX950	95.0	6.1	5R5VX1400	140.0	9.0	5R5V2120	212.0	13.7	5R5V3150	315.0	20.3
2R5VX670	67.0	1.7	2R5VX1000	100.0	2.6	2R5VX1500	150.0	3.9	2R5V2240	224.0	5.8	2R5V3350	335.0	8.7
3R5VX670	67.0	2.5	3R5VX1000	100.0	3.8	3R5VX1500	150.0	5.8	3R5V2240	224.0	8.7	3R5V3350	335.0	13.0
4R5VX670	67.0	3.4	4R5VX1000	100.0	5.1	4R5VX1500	150.0	7.7	4R5V2240	224.0	11.5	4R5V3350	335.0	17.3
5R5VX670	67.0	4.2	5R5VX1000	100.0	6.4	5R5VX1500	150.0	9.6	5R5V2240	224.0	14.4	5R5V3350	335.0	21.6
2R5VX710	71.0	1.8	2R5VX1060	106.0	2.7	2R5VX1600	106.0	4.1	2R5V2360	236.0	6.1	2R5V3550	355.0	9.2
3R5VX710	71.0	2.7	3R5VX1060	106.0	4.1	3R5VX1600	106.0	6.2	3R5V2360	236.0	9.1	3R5V3550	355.0	13.7
4R5VX710	71.0	3.6	4R5VX1060	106.0	5.4	4R5VX1600	106.0	8.2	4R5V2360	236.0	12.2	4R5V3550	355.0	18.3
5R5VX710	71.0	4.5	5R5VX1060	106.0	6.8	5R5VX1600	106.0	10.3	5R5V2360	236.0	15.2	5R5V3550	355.0	22.9

8V NARROW (Ultra-V) BANDED V-BELTS

Product No.	Belt Length	Wt. Lbs.	Product No.	Belt Length	Wt. Lbs.	Product No.	Belt Length	Wt. Lbs.	Product No.	Belt Length	Wt. Lbs.
3R8V1000	100.0	9.9	3R8V1600	160.0	16.0	3R8V2500	250.0	25.2	3R8V4000	400.0	40.5
4R8V1000	100.0	13.2	4R8V1600	160.0	21.4	4R8V2500	250.0	33.6	4R8V4000	400.0	53.9
5R8V1000	100.0	16.5	5R8V1600	160.0	26.7	5R8V2500	250.0	42.0	5R8V4000	400.0	67.4
3R8V1060	106.0	10.5	3R8V1700	170.0	17.0	3R8V2650	265.0	26.7	3R8V4250	425.0	43.0
4R8V1060	106.0	14.0	4R8V1700	170.0	22.7	4R8V2650	265.0	35.6	4R8V4250	425.0	57.3
5R8V1060	106.0	17.5	5R8V1700	170.0	28.4	5R8V2650	265.0	44.5	5R8V4250	425.0	71.7
3R8V1120	112.0	11.1	3R8V1800	180.0	18.0	3R8V2800	280.0	28.2	3R8V4500	450.0	45.5
4R8V1120	112.0	14.8	4R8V1800	180.0	24.1	4R8V2800	280.0	37.6	4R8V4500	450.0	60.7
5R8V1120	112.0	18.5	5R8V1800	180.0	30.1	5R8V2800	280.0	47.1	5R8V4500	450.0	75.9
3R8V1180	118.0	11.7	3R8V1900	190.0	19.1	3R8V3000	300.0	30.3	3R8V4750	475.0	48.1
4R8V1180	118.0	15.6	4R8V1900	190.0	25.4	4R8V3000	300.0	40.4	4R8V4750	475.0	64.1
5R8V1180	118.0	19.6	5R8V1900	190.0	31.8	5R8V3000	300.0	50.4	5R8V4750	475.0	80.2
3R8V1250	125.0	12.4	3R8V2000	200.0	20.1	3R8V3150	315.0	31.8	3R8V5000	500.0	50.6
4R8V1250	125.0	16.6	4R8V2000	200.0	26.8	4R8V3150	315.0	42.4	4R8V5000	500.0	67.5
5R8V1250	125.0	20.7	5R8V2000	200.0	33.5	5R8V3150	315.0	53.0	5R8V5000	500.0	84.4
3R8V1320	132.0	13.2	3R8V2120	212.0	21.3	3R8V3350	335.0	33.8	3R8V5600	560.0	56.7
4R8V1320	132.0	17.5	4R8V2120	212.0	28.4	4R8V3350	335.0	45.1	4R8V5600	560.0	75.7
5R8V1320	132.0	21.9	5R8V2120	212.0	35.5	5R8V3350	335.0	56.4	5R8V5600	560.0	94.6
3R8V1400	140.0	14.0	3R8V2240	224.0	22.5	3R8V3550	355.0	35.9	3R8V6000	600.0	60.8
4R8V1400	140.0	18.6	4R8V2240	224.0	30.0	4R8V3550	355.0	47.8	4R8V6000	600.0	81.0
5R8V1400	140.0	23.3	5R8V2240	224.0	37.5	5R8V3550	355.0	59.8	5R8V6000	600.0	101.3
3R8V1500	150.0	15.0	3R8V2360	236.0	23.8	3R8V3750	375.0	37.9			
4R8V1500	150.0	20.0	4R8V2360	236.0	31.7	4R8V3750	375.0	50.5			
5R8V1500	150.0	25.0	5R8V2360	236.0	39.6	5R8V3750	375.0	63.2			



DRIVE SELECTION – NARROW BELTS

1. Determine DESIGN HORSEPOWER

DESIGN HORSEPOWER = DriveR HP x Service Factor (See below)

SERVICE FACTORS

DRIVEN MACHINE See Note 1	DRIVER					
	AC Normal Torque Electric Motor (NEMA Design A-B) See Note 2			AC High Torque Electric Motor (NEMA Design C-D) See Note 3		
	Intermittent Service See Note 4	Normal Service See Note 5	Continuous Service See Note 6	Intermittent Service See Note 4	Normal Service See Note 5	Continuous Service See Note 6
Agitators for Liquids						
Blowers and Exhausters						
Centrifugal Pumps and Compressors	1.0	1.1	1.2	1.1	1.2	1.3
Conveyors (Light Duty)						
Fans (up to 10 H.P.)						
Belt Conveyors for Sand, Grain, etc.						
Fans (over 10 H.P.)						
Generators						
Laundry Machinery						
Line Shafts						
Machine Tools	1.1	1.2	1.3	1.2	1.3	1.4
Mixers (Dough)						
Positive Displacement Rotary Pumps						
Printing Machinery						
Punches-Presses-Shears See Note 1						
Revolving and Vibrating Screens						
Blowers (Positive Displacement)						
Brick Machinery						
Compressors (Piston) See Note 1						
Conveyors (Drag-Pan-Screw)						
Elevators (Bucket)	1.2	1.3	1.4	1.4	1.5	1.6
Exciters						
Hammer Mills						
Paper Mill Beaters						
Pulverizers						
Pumps (Piston)						
Saw Mill and Woodworking Machinery						
Textile Machinery						
Crushers (Giratory-Jaw-Roll) See Note 1	1.3	1.4	1.5	1.5	1.6	1.8
Mills (Ball-Rod-Tube) See Note 1						
Hoists See Note 1						
Rubber Calenders-Extruders-Mills See Note 1						

Note 1 The Driven Machines listed above are representative samples only. When one of the sheaves of the drive is used as a flywheel to reduce speed fluctuations and equalize the energy exerted at the shaft or for applications involving impact or jam loads specially constructed sheaves may be required. Consult the manufacturer.

Note 2 Included under this heading are the following electric motors: Synchronous and Squirrel Cage AC Normal Torque, AC Split Phase, DC Shunt Wound and Internal Combustion Engines.

Note 3 Included under this heading are the following electric motors: AC High Torque, AC Hi-Slip, AC Repulsion, Induction, AC Single Phase Series Wound, AC Slip Ring and DC Compound Wound.

Note 4 Intermittent Service refers to 3–5 hours of daily or seasonal operation.

Note 5 Normal Service indicates 8–10 hours of daily operation.

Note 6 Continuous Service refers to 16–24 hours of daily operation.

Note 7 If idlers are used, add the following to the service factor.

Idler on slack side (inside)	None
Idler on slack side (outside)	0.1
Idler on tight side (inside)	0.1
Idler on tight side (outside)	0.2

DRIVE SELECTION – NARROW BELTS



2. Select **BELT CROSS SECTION** using chart below.

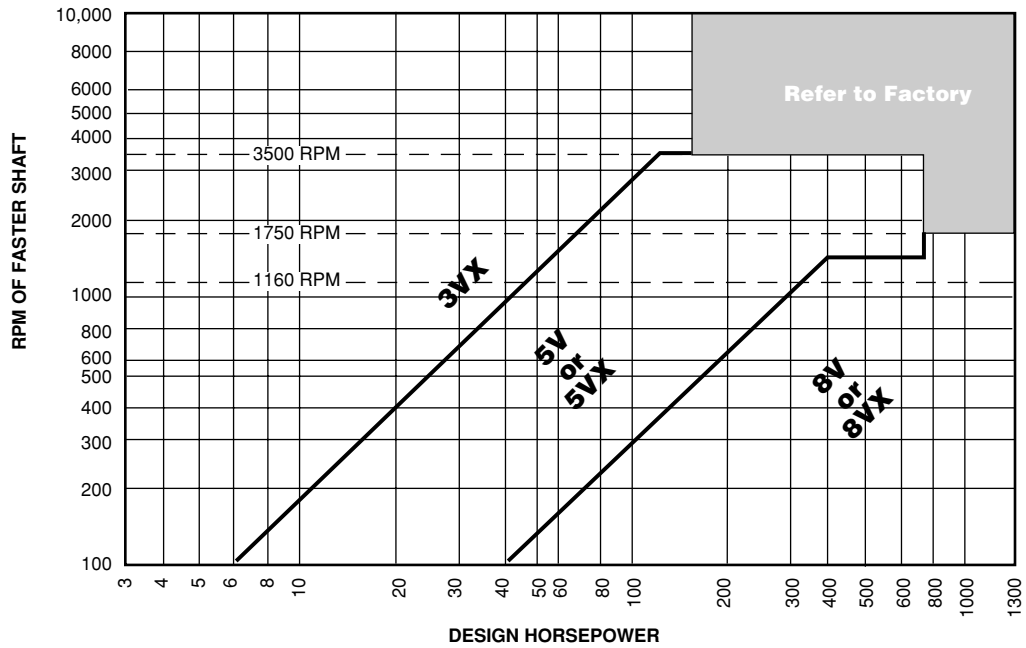

3. If using a 60 HZ electric motor, **Note the Minimum Motor Sheave Outside Diameter recommended by NEMA.**

Motor Horsepower	MOTOR RPM			
	870	1160	1750	3500
1/2	2.2
3/4	2.4	2.2
1	2.4	2.4	2.2	...
1-1/2	2.4	2.4	2.4	2.2
2	3.0	2.4	2.4	2.4
3	3.0	3.0	2.4	2.4
5	3.8	3.0	3.0	2.4
7-1/2	4.4	3.8	3.0	3.0
10	4.4	4.4	3.8	3.0
15	5.2	4.4	4.4	3.8
20	6.0	5.2	4.4	4.4
25	6.8	6.0	4.4	4.4
30	6.8	6.8	5.2	...
40	8.2	6.8	6.0	...
50	8.4	8.2	6.8	...
60	10.0	8.2	7.4	...
75	10.0	10.0	8.6	...
100	12.0	10.0	8.6	...
125	...	12.0	10.5	...
150	10.5	...
200	13.2	...
250
300



DRIVE SELECTION – NARROW BELTS

- BELT LENGTH = $2 \times C + 1.57 \times (D + d) + [(D - d)^2 / 4 \times C]$
- CENTER DISTANCE = $1/2 \times [A - h \times (D - d)]$

WHERE:

C = Center Distance (in.) D = O.D. of larger sheave (in.)
 L = Belt Length (in.) d = O.D. of smaller sheave (in.)
 A = $L - 1.57 \times (D + d)$ h = Factor from chart below

$\frac{D-d}{A}$	h	$\frac{D-d}{A}$	h	$\frac{D-d}{A}$	h	$\frac{D-d}{A}$	h
0.00	0.00	0.16	0.08	0.30	0.16	0.43	0.24
0.02	0.01	0.18	0.09	0.32	0.17	0.44	0.25
0.04	0.02	0.20	0.10	0.34	0.18	0.46	0.26
0.06	0.03	0.21	0.11	0.35	0.19	0.47	0.27
0.08	0.04	0.23	0.12	0.37	0.20	0.48	0.28
0.10	0.05	0.25	0.13	0.39	0.21	0.50	0.29
0.12	0.06	0.27	0.14	0.40	0.22	0.51	0.30
0.14	0.07	0.29	0.15	0.41	0.23

AC FACTORS

$\frac{D-d}{C}$	Factor Ac	$\frac{D-d}{C}$	Factor Ac
0.000	1.000	0.750	0.879
0.025	0.997	0.775	0.874
0.050	0.994	0.800	0.869
0.075	0.990	0.825	0.864
0.100	0.987	0.850	0.858
0.125	0.983	0.875	0.852
0.150	0.980	0.900	0.847
0.175	0.977	0.925	0.841
0.200	0.973	0.950	0.835
0.225	0.969	0.975	0.829
0.250	0.966	1.000	0.823
0.275	0.962	1.025	0.816
0.300	0.958	1.050	0.810
0.325	0.954	1.075	0.803
0.350	0.951	1.100	0.796
0.375	0.947	1.125	0.789
0.400	0.943	1.150	0.782
0.425	0.939	1.175	0.774
0.450	0.935	1.200	0.767
0.475	0.930	1.225	0.759
0.500	0.926	1.250	0.751
0.525	0.922	1.275	0.742
0.550	0.917	1.300	0.734
0.575	0.913	1.325	0.725
0.600	0.908	1.350	0.716
0.625	0.904	1.375	0.706
0.650	0.899	1.400	0.697
0.675	0.894	1.425	0.687
0.700	0.889		
0.725	0.884		

LC FACTORS

Belt No.	Correction Factor Lc	Belt No.	Correction Factor Lc	Belt No.	Correction Factor Lc
3VX250	.83	5VX500	.85	8VX1060	.88
3VX265	.84	5VX530	.86	8VX1120	.88
3VX280	.85	5VX560	.87	8VX1180	.89
3VX300	.86	5VX600	.88	8VX1250	.90
3VX315	.87	5VX630	.89	8VX1320	.91
3VX335	.88	5VX670	.90	8VX1400	.92
3VX355	.89	5VX710	.91	8VX1500	.93
3VX375	.90	5VX750	.92	8VX1600	.94
3VX400	.92	5VX800	.93	8VX1700	.94
3VX425	.93	5VX850	.94	8VX1800	.95
3VX450	.94	5VX900	.95	8VX1900	.96
3VX475	.95	5VX950	.95	8VX2000	.97
3VX500	.96	5VX1000	.96	8V2120	.97
3VX530	.97	5VX1060	.97	8V2240	.98
3VX560	.98	5VX1120	.98	8V2360	.99
3VX600	.99	5VX1180	.99	8V2500	1.00
3VX630	1.00	5VX1250	1.00	8V2650	1.01
3VX670	1.01	5VX1320	1.01	8V2800	1.02
3VX710	1.02	5VX1400	1.02	8V3000	1.02
3VX750	1.03	5VX1500	1.03	8V3150	1.03
3VX800	1.04	5VX1600	1.04	8V3350	1.04
3VX850	1.05	5VX1700	1.05	8V3550	1.05
3VX900	1.07	5VX1800	1.06	8V3750	1.06
3VX950	1.08	5VX1900	1.07	8V4000	1.07
3VX1000	1.09	5VX2000	1.08	8V4250	1.08
3VX1060	1.10	5V2120	1.09	8V4500	1.09
3VX1120	1.11	5V2240	1.09	8V4750	1.09
3VX1180	1.12	5V2360	1.10	8V5000	1.10
3VX1250	1.13	5V2500	1.11		
3VX1320	1.14	5V2650	1.12		
3VX1400	1.15	5V2800	1.13		
		5V3000	1.14		
		5V3150	1.15		
		5V3350	1.16		
		5V3550	1.17		

BALANCING STANDARDS



Proper balance of rotating products is important for smooth, vibration-free operation. Standard balance of Wood's stock products is a one plane balance. Depending on the face width, outside diameter, and operating speed a higher precision balance may be required for smooth operation. In those cases a two-plane balance is suggested.

Note: Two plane balance is for smooth operation only and DOES NOT increase the maximum safe operating speed of the product. Stock cast iron wheels may not exceed 6,550 feet per minute; and ductile iron wheels are limited to 10,000 FPM. (FPM = sheave outside diameter x RPM x .262)

The nomograph below may be used as a guideline to determine when two-plane balance is recommended. To use this chart lay a straight-edge between the diameter of the part on the left of the chart and the face width of the part on the right. The straight edge will intersect the slanted scale in the center of the chart. When the operating speed is greater than the intersection point a two-plane balance is recommended.

Example: If a 20 in. diameter x 10 in. face width sheave runs faster than 1100 rpm, dynamic balancing is recommended.

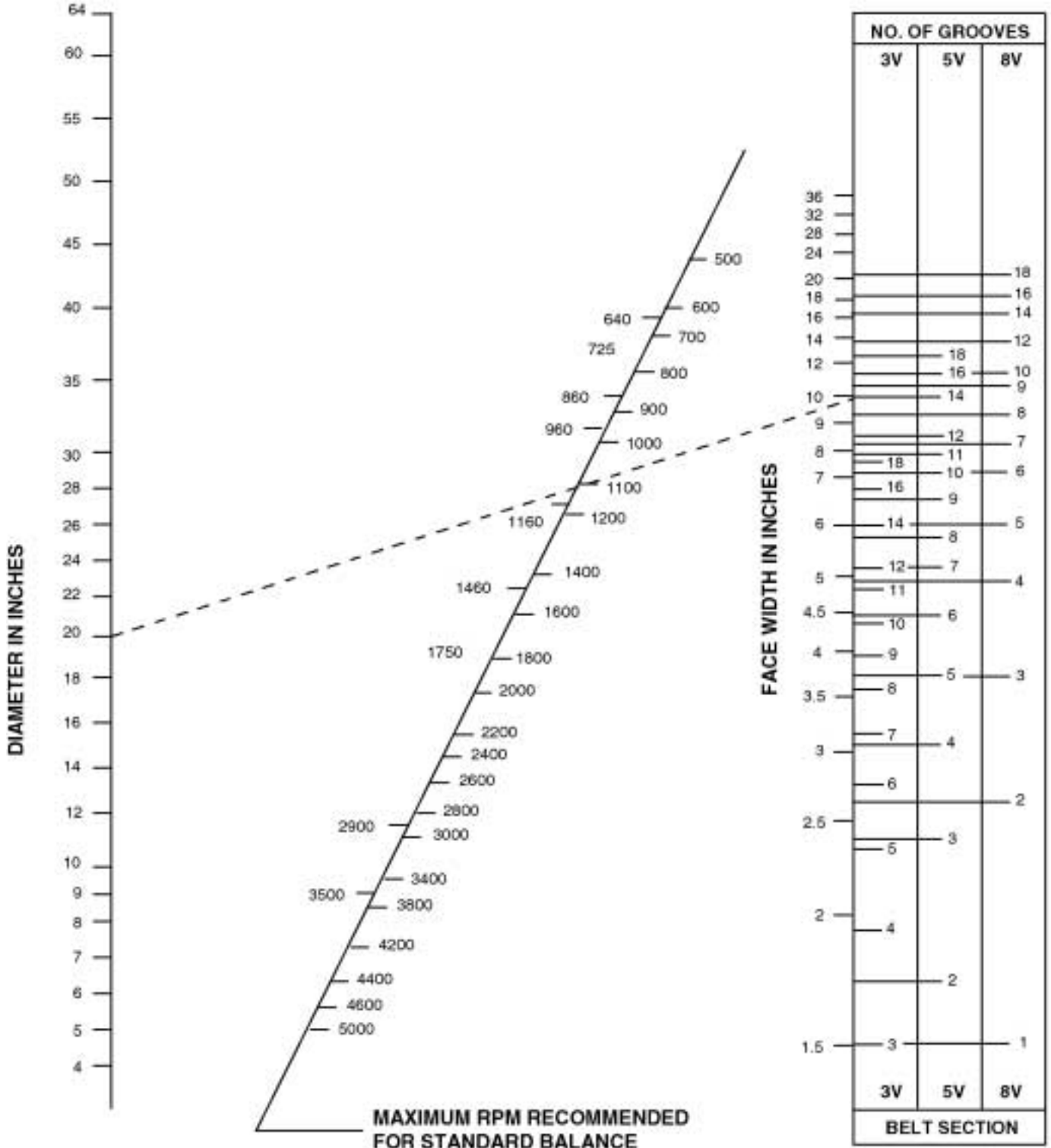

DRIVE SELECTION – NARROW BELTS

Using Pre-Engineered Drive Selection Tables



Standard Motor Speed - Reduction or 1:1 Ratio Drives

Example: A 15 HP 1750 RPM NEMA B motor driving a piston pump operating at 438 RPM, 18 hours a day.
Motor shaft is 1-5/8" diameter, Pump shaft is 2-1/4" diameter, center distance between shafts is 25".

Procedure	Example																		
Step #1: Calculate the Design Horsepower DHP = DriveR HP x service factor (page B1-14)	Service Factor = 1.4 DHP = 15 HP x 1.4 SF = 21																		
Step #2: Choose the Belt Cross Section Reference Chart (page B1-15)	21 DHP and 1750 RPM falls in the 3VX section																		
Step #3: Check NEMA recommended Minimum Motor Sheave Outside Diameter (page B1-15)	NEMA minimum O.D. for a 15 HP 1750 RPM motor is 4.4 inches																		
Step #4: Calculate Speed Ratio Speed Ratio = DriveR RPM / DriveN RPM	Speed Ratio = 1750 RPM / 438 RPM = 4.0																		
Step #5: In the Drive Selection Tables corresponding to the correct belt section, locate the drive line with the same ratio. In the event of multiple lines, drives using larger diameters are usually more economical.	Lines 232 and 233 (page B1-30) are a 4.0 ratio. Line 233 should be used because line 232 has a 2.65 diameter driver which is below the NEMA recommended minimum.																		
Step #6: Note the following information from the drive line: DriveR sheave diameter DriveN sheave diameter Actual RPM - Under the corresponding motor RPM HP Rating Per Belt - Under the corresponding motor RPM Select the desired CD - To the right of the RPM and HP Arc-Length Correction Factor - Bold type above/below CD Belt Length - Column header above Selected CD	From line 233 DriveR OD = 4.75 DriveN OD = 19.0 DriveN speed = 438 RPM when DriveR @ 1750 RPM HP Per Belt = 6.04 HP when DriveR @ 1750 RPM CD = 25.3" Arc Length Correction Factor = .94 3VX900																		
Step #7: Calculate corrected HP per Belt CHP = HP per Belt x Arc Length Correction Factor	CHP = 6.04 x .94 = 5.68																		
Step #8: Determine number of belts required NOB = Design HP / CHP	NOB = 21 DHP / 5.68 CHP = 3.7 • use 4 belts																		
Step #9: Check for Dynamic Balance Recommendations Reference Chart (page B1-17)	OK as Standard - 3V4.75 x 4 static balance good to 4700 RPM OK as Standard - 3V19.0 x 4 static balance good to 2600 RPM																		
Step #10: Specify Drive Components Reference Component Dimensional pages for Product Number	<table style="width: 100%; border-collapse: collapse;"> <thead> <tr> <th style="text-align: left;">Item</th> <th style="text-align: left;">Product No.</th> <th style="text-align: left;">Ref. Page</th> </tr> </thead> <tbody> <tr> <td>DR - 3V4.75 x 4 sheave</td> <td>3V4754</td> <td>(B1-4)</td> </tr> <tr> <td>- SDS Bushing for 1-5/8" bore</td> <td>SDS158</td> <td>(A1-4)</td> </tr> <tr> <td>DN - 3V19.0 x 4 sheave</td> <td>3V1904</td> <td>(B1-4)</td> </tr> <tr> <td>- SF Bushing for 2-1/4" bore</td> <td>SF214</td> <td>(A1-4)</td> </tr> <tr> <td>Belts - Qty. of 4 belts</td> <td>3VX900</td> <td>(B1-12)</td> </tr> </tbody> </table>	Item	Product No.	Ref. Page	DR - 3V4.75 x 4 sheave	3V4754	(B1-4)	- SDS Bushing for 1-5/8" bore	SDS158	(A1-4)	DN - 3V19.0 x 4 sheave	3V1904	(B1-4)	- SF Bushing for 2-1/4" bore	SF214	(A1-4)	Belts - Qty. of 4 belts	3VX900	(B1-12)
Item	Product No.	Ref. Page																	
DR - 3V4.75 x 4 sheave	3V4754	(B1-4)																	
- SDS Bushing for 1-5/8" bore	SDS158	(A1-4)																	
DN - 3V19.0 x 4 sheave	3V1904	(B1-4)																	
- SF Bushing for 2-1/4" bore	SF214	(A1-4)																	
Belts - Qty. of 4 belts	3VX900	(B1-12)																	



DRIVE SELECTION – NARROW BELTS

Using Drive Selection Tables and HP Rating Tables

Speeds Other than Common Motor Speeds and Speed-Up Applications

Example: A 20 HP 1900 RPM internal combustion engine driving a hammer mill operating at 3097 RPM, 8 hours a day. Motor shaft is 1-7/8" diameter, Mill shaft is 1-5/8" diameter, center distance between shafts is 36".

Procedure	Example																		
Step #1: Calculate the Design Horsepower DHP = DriveR HP x service factor (page B1-14)	Service Factor = 1.3 DHP = 20 HP x 1.3 = 26																		
Step #2: Choose the Belt Cross Section Reference chart (page B1-15)	26 DHP and 1900 RPM falls in the 3VX section																		
Step #3: Check NEMA recommended Minimum Motor Sheave Outside Diameter (page B1-15)	Does Not Apply - DriveR not NEMA Motor																		
Step #4: Calculate Speed Ratio Speed Ratio = Faster RPM / Slower RPM	Speed Ratio = 3097 RPM / 1900 RPM = 1.63																		
Step #5: In the Drive Selection Tables corresponding to the correct belt section, locate the drive line with the same ratio. In the event of multiple lines, drives using larger diameters are usually more economical.	Line 121 is a 1.63 ratio. Due to the application being a speed-up drive the DriveR and DriveN sheave are reversed in the table. Actual RPM = 1900 DriveR RPM x 1.63 = 3097 DriveN RPM																		
Step #6: Note the following information from the drive line: DriveR sheave diameter DriveN sheave diameter Select the desired CD - On the right hand page Arc-Length Correction Factor - Bold type above/below CD Belt Length - Column header above Selected CD	From line 121 DriveR OD = 10.6 DriveN OD = 6.5 CD = 36.5" Arc Length Correction Factor = 1.09 3VX1000																		
Step #7: In the HP Rating Tables, following the Drive Selection Tables, locate the HP per Belt under the correct Belt Section. (Use Small Sheave Diameter and RPM)	3VX HP Rating Tables (page B1-62 to 63) 6.5 diameter sheave @ 3097 RPM - HP/Belt = 13.4 NOTE: Interpolate between values to get 13.4																		
Step #8: Calculate corrected HP per Belt Add on for ratio is found to the right of the HP Rating Tables CHP = (HP per Belt + Add on) x Arc Length Correction Factor	Add on for 1.63 ratio = .47 CHP = (13.4 + .49) x 1.09 = 15.1																		
Step #9: Determine number of belts required NOB = Design HP / CHP	NOB = 26 DHP / 15.1 CHP = 1.7 • use 2 belts																		
Step #10: Check for Dynamic Balance Recommendations Reference Chart (page B1-17)	OK as Standard - 3V10.6 x 2 static balance good to 3600 RPM OK as Standard - 3V6.5 x 2 static balance good to 5850 RPM																		
Step #11: Stock cast iron parts are good to 6500 FPM If operating faster MTO ductile iron is required. FPM = diameter (in.) x RPM x .262	FPM = 10.6 x 1900 x .262 = 5277 FPM Stock cast iron parts are OK																		
Step #12: Specify Drive Components Reference Component Dimensional pages for Product Number	<table border="0"> <thead> <tr> <th>Item</th> <th>Product No.</th> <th>Ref. Page</th> </tr> </thead> <tbody> <tr> <td>DR - 3V10.6 x 2 sheave</td> <td>3V1062</td> <td>(B1-4)</td> </tr> <tr> <td>- SK Bushing for 1-7/8" bore</td> <td>SK178</td> <td>(A1-5)</td> </tr> <tr> <td>DN - 3V6.5 x 2 sheave</td> <td>3V652</td> <td>(B1-4)</td> </tr> <tr> <td>- SDS Bushing for 1-5/8" bore</td> <td>SDS158</td> <td>(A1-4)</td> </tr> <tr> <td>Belts - Qty. of 2 belts</td> <td>3VX1000</td> <td>(B1-12)</td> </tr> </tbody> </table>	Item	Product No.	Ref. Page	DR - 3V10.6 x 2 sheave	3V1062	(B1-4)	- SK Bushing for 1-7/8" bore	SK178	(A1-5)	DN - 3V6.5 x 2 sheave	3V652	(B1-4)	- SDS Bushing for 1-5/8" bore	SDS158	(A1-4)	Belts - Qty. of 2 belts	3VX1000	(B1-12)
Item	Product No.	Ref. Page																	
DR - 3V10.6 x 2 sheave	3V1062	(B1-4)																	
- SK Bushing for 1-7/8" bore	SK178	(A1-5)																	
DN - 3V6.5 x 2 sheave	3V652	(B1-4)																	
- SDS Bushing for 1-5/8" bore	SDS158	(A1-4)																	
Belts - Qty. of 2 belts	3VX1000	(B1-12)																	

DRIVE SELECTION – NARROW BELTS

MTO Drive Design



Non-Stock Diameters

Example: A 125 HP 1160 RPM motor driving a Piston Air Compressor operating at 800 RPM, 24 hours a day.
The motor shaft is 3-3/8", the Compressor is supplied with a 5V30.5 x 4 flywheel sheave mounted,
the center distance is 59".

Procedure	Example															
Step #1: Calculate the Design Horsepower DHP = DriveR HP x service factor (page B1-14)	Service Factor = 1.4 DHP = 125 HP x 1.4 = 175															
Step #2: Choose the Belt Cross Section Reference chart (page B1-15)	175 DHP and 1160 RPM intersect in the 5VX section <i>This agrees with the sheave supplied with the compressor</i>															
Step #3: Check NEMA recommended Minimum Motor Sheave Outside Diameter (page B1-15)	Minimum O.D. for a 125 HP 1160 RPM motor is 12.0 inches															
Step #4: Calculate Speed Ratio Speed Ratio = Faster RPM / Slower RPM	Speed Ratio = 1160 RPM / 800 RPM = 1.45															
Step #5: Use the Ratio and any diameter limits or known sheaves to determine the diameters of DriveR and DriveN. Try to utilize stock parts when possible.	5V30.5 x 4 Known DriveN Sheave 30.5 DriveN Sheave / 1.45 Ratio = 21.03 DriveR Sheave Use Stock 5V21.2 stock sheave															
Step #6: Using the diameter of the sheave the actual ratio and speed can be calculated.	Actual Ratio = 30.5 DriveN / 21.2 DriveR = 1.44 Actual RPM = 1160 RPM DriveR / 1.44 = 806 RPM DriveN															
Step #7: Calculate Belt Length to determine the closest stock belt. Then calculate the actual CD using the stock belt. (Formulas on page B1-16)	$BL = 2 \times 59 + 1.57 \times (30.5 + 21.2) + [(30.5 - 21.2)^2 / (4 \times 59)]$ BL = 199.5 • use a 5VX2000 Belt A = 200 - 1.57 x (30.5 + 21.2) = 118.8 CD = 1/2 x [118.8 - .04 x (30.5 - 21.2)] = 59.2"															
Step #8: Find the AC and LC correction factors. (page B1-16)	AC factor = .980 LC factor for 5VX2000 belts = 1.08															
Step #9: In the HP Rating Tables, following the Drive Selection Tables, locate the HP per Belt under the correct Belt Section. (Use Small Sheave Diameter and RPM)	5VX rating tables (page B1-64 to 65) 21.2 diameter @ 1160 RPM – HP / Belt = 52.0															
Step #10: Calculate corrected HP per Belt Add on for ratio is found to the right of the HP Rating Tables CHP = (HP per Belt + Add on) x AC x LC	Add on for 1.44 ratio = .79 CHP = (52.0 + .79) x .98 x 1.08 = 55.87															
Step #11: Determine number of belts required NOB = Design HP / CHP	NOB = 175 DHP / 55.87 CHP = 3.13 • use 4 belts															
Step #12: Check for Dynamic Balance Recommendations Reference Chart (page B1-17)	OK as Standard - 5V21.2 x 4 standard balance good to 1800 RPM OK as Standard - 5V30.5 x 4 standard balance good to 1250 RPM															
Step #13: Stock cast iron parts are good to 6500 FPM. If operating faster MTO ductile iron is required. FPM = diameter (in.) x RPM x .262	FPM = 21.2 x 1160 x .262 = 6443 FPM Standard Cast Iron Parts are OK															
Step #14: Specify Drive Components Reference Component Dimensional pages for Product Number	<table border="0"> <thead> <tr> <th>Item</th> <th>Product No.</th> <th>Ref. Page</th> </tr> </thead> <tbody> <tr> <td>DR - 5V21.2 x 4 sheave</td> <td>5V2124</td> <td>(B1-6)</td> </tr> <tr> <td>- E Bushing for 3-3/8" bore</td> <td>E338</td> <td>(A1-5)</td> </tr> <tr> <td>DN - Existing 5V30.5 x 4 sheave</td> <td></td> <td></td> </tr> <tr> <td>Belts - Qty. of 4 belts</td> <td>5VX2000</td> <td>(B1-12)</td> </tr> </tbody> </table>	Item	Product No.	Ref. Page	DR - 5V21.2 x 4 sheave	5V2124	(B1-6)	- E Bushing for 3-3/8" bore	E338	(A1-5)	DN - Existing 5V30.5 x 4 sheave			Belts - Qty. of 4 belts	5VX2000	(B1-12)
Item	Product No.	Ref. Page														
DR - 5V21.2 x 4 sheave	5V2124	(B1-6)														
- E Bushing for 3-3/8" bore	E338	(A1-5)														
DN - Existing 5V30.5 x 4 sheave																
Belts - Qty. of 4 belts	5VX2000	(B1-12)														



3VX BELTS IN 3V SHEAVES

LINE #	RATIO	STOCK SHEAVES			DRIVEN SPEEDS AND HORSEPOWER RATINGS PER BELT					
		Datum Diameter		Number Grooves	1160 RPM		1750 RPM		3500 RPM	
		DR	DN		Driven Speed	H.P. Ratings	Driven Speed	H.P. Ratings	Driven Speed	H.P. Ratings
1	1.00	2.20	2.20	1-2	1160	1.04	1750	1.46	3500	2.49
2	1.00	2.35	2.35	1-2	1160	1.22	1750	1.72	3500	2.98
3	1.00	2.50	2.50	1-3	1160	1.40	1750	1.98	3500	3.46
4	1.00	2.65	2.65	1-4	1160	1.58	1750	2.24	3500	3.94
5	1.00	2.80	2.80	1-4	1160	1.75	1750	2.49	3500	4.41
6	1.00	3.00	3.00	1-4	1160	1.99	1750	2.84	3500	5.03
7	1.00	3.15	3.15	1-4	1160	2.16	1750	3.09	3500	5.50
8	1.00	3.35	3.35	1-4	1160	2.39	1750	3.43	3500	6.11
9	1.00	3.65	3.65	1-4	1160	2.74	1750	3.93	3500	7.01
10	1.00	4.12	4.12	1-4	1160	3.28	1750	4.71	3500	8.38
11	1.00	4.50	4.50	1-4	1160	3.71	1750	5.33	3500	9.46
12	1.00	4.75	4.75	1-6,8,10	1160	3.99	1750	5.73	3500	10.14
13	1.00	5.00	5.00	1-6,8,10	1160	4.27	1750	6.14	3500	10.82
14	1.00	5.30	5.30	1-6,8,10	1160	4.60	1750	6.61	3500	11.61
15	1.00	5.60	5.60	1-6,8,10	1160	4.94	1750	7.09	3500	12.37
16	1.00	6.00	6.00	1-6,8,10	1160	5.38	1750	7.71	3500	13.36
17	1.00	6.50	6.50	1-6,8,10	1160	5.92	1750	8.48	3500	14.52
18	1.00	6.90	6.90	1-6,8,10	1160	6.35	1750	9.09	3500	15.41
19	1.00	8.00	8.00	1-6,8,10	1160	7.52	1750	10.71
20	1.00	10.60	10.60	1-6,8,10	1160	10.18	1750	14.28
21	1.05	3.00	3.15	1-4	1105	2.03	1667	2.89	3333	5.15
22	1.05	4.75	5.00	1-6,8,10	1102	4.03	1663	5.80	3325	10.27
23	1.06	4.50	4.75	1-4	1099	3.75	1658	5.39	3316	9.59
24	1.06	2.65	2.80	1-4	1098	1.62	1656	2.30	3313	4.07
25	1.06	5.30	5.60	1-6,8,10	1098	4.65	1656	6.68	3313	11.74
26	1.06	2.50	2.65	1-3	1094	1.44	1651	2.05	3302	3.60
27	1.06	5.00	5.30	1-6,8,10	1094	4.32	1651	6.20	3302	10.96
28	1.06	6.50	6.90	1-6,8,10	1093	5.97	1649	8.55	3297	14.67
29	1.06	3.15	3.35	1-4	1091	2.21	1646	3.16	3291	5.64
30	1.06	2.35	2.50	1-2	1090	1.27	1645	1.79	3290	3.12
31	1.07	2.20	2.35	1-2	1086	1.09	1638	1.53	3277	2.64
32	1.07	2.80	3.00	1-4	1083	1.81	1633	2.57	3267	4.57
33	1.07	5.60	6.00	1-6,8,10	1083	4.99	1633	7.17	3267	12.53
34	1.08	6.00	6.50	1-6,8,10	1071	5.44	1615	7.80	3231	13.54
35	1.09	3.35	3.65	1-4	1065	2.46	1606	3.52	3212	6.30
36	1.09	4.12	4.50	1-4	1062	3.34	1602	4.81	3204	8.58
37	1.11	4.50	5.00	1-4	1044	3.78	1575	5.44	3150	9.68
38	1.12	4.75	5.30	1-6,8,10	1040	4.07	1568	5.85	3137	10.38
39	1.12	3.00	3.35	1-4	1039	2.07	1567	2.95	3134	5.27
40	1.12	2.50	2.80	1-3	1036	1.48	1563	2.10	3125	3.70
41	1.12	5.00	5.60	1-6,8,10	1036	4.35	1563	6.26	3125	11.06
42	1.13	2.80	3.15	1-4	1031	1.84	1556	2.62	3111	4.66
43	1.13	2.35	2.65	1-2	1029	1.30	1552	1.84	3104	3.23
44	1.13	3.65	4.12	1-4	1028	2.82	1550	4.06	3101	7.26
45	1.13	2.65	3.00	1-4	1025	1.66	1546	2.37	3092	4.20
46	1.13	5.30	6.00	1-6,8,10	1025	4.69	1546	6.74	3092	11.87
47	1.14	2.20	2.50	1-2	1021	1.13	1540	1.59	3080	2.75
48	1.15	6.00	6.90	1-6,8,10	1009	5.47	1522	7.85	3043	13.64
49	1.15	4.12	4.75	1-4	1006	3.37	1518	4.85	3036	8.67
50	1.16	3.15	3.65	1-4	1001	2.26	1510	3.24	3021	5.79

DRIVE SELECTION TABLES



CENTER DISTANCE AND COMBINED ARC-LENGTH CORRECTION FACTOR ▲																LINE #	
3VX 250	3VX 280	3VX 315	3VX 355	3VX 400	3VX 450	3VX 500	3VX 560	3VX 600	3VX 710	3VX 750	3VX 800	3VX 900	3VX 1000	3VX 1120	3VX 1250		
9.0	10.5	12.3	14.3	16.5	19.0	21.5	24.5	26.5	32.0	34.0	36.5	41.5	46.5	52.5	59.0	1	
8.8	10.3	12.1	14.1	16.3	18.8	21.3	24.3	26.3	31.8	33.8	36.3	41.3	46.3	52.3	58.8	2	
8.6	10.1	11.8	13.8	16.1	18.6	21.1	24.1	26.1	31.6	33.6	36.1	41.1	46.1	52.1	58.6	3	
8.3	9.8	11.6	13.6	15.8	18.3	20.8	23.8	25.8	31.3	33.3	35.8	40.8	45.8	51.8	58.3	4	
8.1	9.6	11.4	13.4	15.6	18.1	20.6	23.6	25.6	31.1	33.1	35.6	40.6	45.6	51.6	58.1	5	
■ 0.80	0.83	0.85	0.88	0.90	0.93	0.95	0.98	0.99	1.03	1.04	1.05	1.08	1.10	1.12	1.15	■	6
7.8	9.3	11.0	13.0	15.3	17.8	20.3	23.3	25.3	30.8	32.8	35.3	40.3	45.3	51.3	57.8	7	
7.6	9.1	10.8	12.8	15.1	17.6	20.1	23.1	25.1	30.6	32.6	35.1	40.1	45.1	51.1	57.6	8	
7.2	8.7	10.5	12.5	14.7	17.2	19.7	22.7	24.7	30.2	32.2	34.7	39.7	44.7	50.7	57.2	9	
6.8	8.3	10.0	12.0	14.3	16.8	19.3	22.3	24.3	29.8	31.8	34.3	39.3	44.3	50.3	56.8	10	
6.0	7.5	9.3	11.3	13.5	16.0	18.5	21.5	23.5	29.0	31.0	33.5	38.5	43.5	49.5	56.0	11	
■ 0.80	0.83	0.85	0.88	0.90	0.93	0.95	0.98	0.99	1.03	1.04	1.05	1.08	1.10	1.12	1.15	■	12
...	6.9	8.7	10.7	12.9	15.4	17.9	20.9	22.9	28.4	30.4	32.9	37.9	42.9	48.9	55.4	13	
...	6.5	8.3	10.3	12.5	15.0	17.5	20.5	22.5	28.0	30.0	32.5	37.5	42.5	48.5	55.0	14	
...	...	7.9	9.9	12.1	14.6	17.1	20.1	22.1	27.6	29.6	32.1	37.1	42.1	48.1	54.6	15	
...	...	7.4	9.4	11.7	14.2	16.7	19.7	21.7	27.2	29.2	31.7	36.7	41.7	47.7	54.2	16	
...	9.0	11.2	13.7	16.2	19.2	21.2	26.7	28.7	31.2	36.2	41.2	47.2	53.7	17	
■	0.83	0.85	0.88	0.90	0.93	0.95	0.98	0.99	1.03	1.04	1.05	1.08	1.10	1.12	1.15	■	18
...	8.3	10.6	13.1	15.6	18.6	20.6	26.1	28.1	30.6	35.6	40.6	46.6	53.1	19	
...	9.8	12.3	14.8	17.8	19.8	25.3	27.3	29.8	34.8	39.8	45.8	52.3	20	
...	9.2	11.7	14.2	17.2	19.2	24.7	26.7	29.2	34.2	39.2	45.2	51.7	21	
...	9.9	12.4	15.4	17.4	22.9	24.9	27.4	32.4	37.4	43.4	49.9	22	
...	13.3	18.8	20.8	23.3	28.3	33.3	39.3	45.8	23	
■			0.88	0.90	0.93	0.95	0.98	0.99	1.03	1.04	1.05	1.08	1.10	1.12	1.15	■	24
7.7	9.2	10.9	12.9	15.2	17.7	20.2	23.2	25.2	30.7	32.7	35.2	40.2	45.2	51.2	57.7	25	
...	...	8.1	10.1	12.3	14.8	17.3	20.3	22.3	27.8	29.8	32.3	37.3	42.3	48.3	54.8	26	
...	6.7	8.5	10.5	12.7	15.2	17.7	20.7	22.7	28.2	30.2	32.7	37.7	42.7	48.7	55.2	27	
8.2	9.7	11.5	13.5	15.7	18.2	20.7	23.7	25.7	31.2	33.2	35.7	40.7	45.7	51.7	58.2	28	
...	9.2	11.4	13.9	16.4	19.4	21.4	26.9	28.9	31.4	36.4	41.4	47.4	53.9	29	
■ 0.80	0.83	0.85	0.88	0.90	0.93	0.95	0.97	0.99	1.02	1.04	1.05	1.07	1.10	1.12	1.14	■	30
8.5	10.0	11.7	13.7	16.0	18.5	21.0	24.0	26.0	31.5	33.5	36.0	41.0	46.0	52.0	58.5	31	
...	...	7.7	9.7	11.9	14.4	16.9	19.9	21.9	27.4	29.4	31.9	36.9	41.9	47.9	54.4	32	
...	9.5	12.0	14.5	17.5	19.5	25.0	27.0	29.5	34.5	39.5	45.5	52.0	33	
7.4	8.9	10.6	12.6	14.9	17.4	19.9	22.9	24.9	30.4	32.4	34.9	39.9	44.9	50.9	57.4	34	
8.7	10.2	11.9	13.9	16.2	18.7	21.2	24.2	26.2	31.7	33.7	36.2	41.2	46.2	52.2	58.7	35	
■ 0.80	0.83	0.85	0.88	0.90	0.93	0.95	0.97	0.99	1.02	1.04	1.05	1.07	1.10	1.12	1.14	■	36
8.9	10.4	12.2	14.2	16.4	18.9	21.4	24.4	26.4	31.9	33.9	36.4	41.4	46.4	52.4	58.9	37	
7.9	9.4	11.2	13.2	15.4	17.9	20.4	23.4	25.4	30.9	32.9	35.4	40.4	45.4	51.4	57.9	38	
...	8.6	10.9	13.4	15.9	18.9	20.9	26.4	28.4	30.9	35.9	40.9	46.9	53.4	39	
...	10.2	12.7	15.2	18.2	20.2	25.7	27.7	30.2	35.2	40.2	46.2	52.7	40	
7.0	8.5	10.3	12.3	14.5	17.0	19.5	22.5	24.5	30.0	32.0	34.5	39.5	44.5	50.5	57.0	41	
■ 0.80	0.83	0.85	0.88	0.90	0.93	0.95	0.97	0.99	1.02	1.04	1.05	1.07	1.10	1.12	1.14	■	42
...	7.2	9.0	11.0	13.2	15.7	18.2	21.2	23.2	28.7	30.7	33.2	38.2	43.2	49.2	55.7	43	
...	6.5	8.3	10.3	12.5	15.0	17.5	20.5	22.5	28.0	30.0	32.5	37.5	42.5	48.5	55.0	44	
...	...	7.9	9.9	12.1	14.6	17.1	20.1	22.1	27.6	29.6	32.1	37.1	42.1	48.1	54.6	45	
7.5	9.0	10.8	12.8	15.0	17.5	20.0	23.0	25.0	30.5	32.5	35.0	40.0	45.0	51.0	57.5	46	
8.3	9.8	11.6	13.6	15.8	18.3	20.8	23.8	25.8	31.3	33.3	35.8	40.8	45.8	51.8	58.3	47	
■ 0.80	0.82	0.85	0.87	0.90	0.93	0.95	0.97	0.99	1.02	1.04	1.05	1.07	1.10	1.12	1.14	■	48
...	...	7.4	9.4	11.7	14.2	16.7	19.7	21.7	27.2	29.2	31.7	36.7	41.7	47.7	54.2	49	
7.8	9.3	11.1	13.1	15.3	17.8	20.3	23.3	25.3	30.8	32.8	35.3	40.3	45.3	51.3	57.8	50	
8.6	10.1	11.8	13.8	16.1	18.6	21.1	24.1	26.1	31.6	33.6	36.1	41.1	46.1	52.1	58.6	41	
6.4	7.9	9.6	11.6	13.9	16.4	18.9	21.9	23.9	29.4	31.4	33.9	38.9	43.9	49.9	56.4	42	
8.1	9.6	11.3	13.3	15.6	18.1	20.6	23.6	25.6	31.1	33.1	35.6	40.6	45.6	51.6	58.1	43	
■ 0.80	0.82	0.85	0.87	0.90	0.93	0.95	0.97	0.99	1.02	1.04	1.05	1.07	1.10	1.12	1.14	■	44
...	8.9	11.1	13.6	16.1	19.1	21.1	26.6	28.6	31.1	36.1	41.1	47.1	53.6	45	
8.8	10.3	12.1	14.1	16.3	18.8	21.3	24.3	26.3	31.8	33.8	36.3	41.3	46.3	52.3	58.8	46	
...	9.9	12.4	14.9	17.9	19.9	25.4	27.4	29.9	34.9	39.9	45.9	52.4	47	
...	7.0	8.8	10.8	13.0	15.5	18.0	21.0	23.0	28.5	30.5	33.0	38.0	43.0	49.0	55.5	48	
7.2	8.7	10.4	12.4	14.7	17.2	19.7	22.7	24.7	30.2	32.2	34.7	39.7	44.7	50.7	57.2	49	
■ 0.80	0.82	0.85	0.87	0.90	0.92	0.95	0.97	0.99	1.02	1.03	1.05	1.07	1.10	1.12	1.14	■	50

▲ Not all available belt lengths are shown.

■ Combined Arc-Length correction factors for 5 preceding lines.



3VX BELTS IN 3V SHEAVES

LINE #	RATIO	STOCK SHEAVES			DRIVEN SPEEDS AND HORSEPOWER RATINGS PER BELT					
		Datum Diameter		Number Grooves	1160 RPM		1750 RPM		3500 RPM	
		DR	DN		Driven Speed	H.P. Ratings	Driven Speed	H.P. Ratings	Driven Speed	H.P. Ratings
51	1.16	6.90	8.00	1-6,8,10	1001	6.45	1509	9.23	3019	15.70
52	1.16	5.60	6.50	1-6,8,10	999	5.03	1508	7.23	3015	12.67
53	1.18	4.50	5.30	1-4	985	3.81	1486	5.49	2972	9.77
54	1.18	4.75	5.60	1-6,8,10	984	4.10	1484	5.89	2969	10.46
55	1.19	2.65	3.15	1-4	976	1.68	1472	2.40	2944	4.26
56	1.19	2.35	2.80	1-2	974	1.33	1469	1.88	2938	3.31
57	1.20	2.80	3.35	1-4	970	1.86	1463	2.66	2925	4.75
58	1.20	2.50	3.00	1-3	967	1.51	1458	2.15	2917	3.80
59	1.20	5.00	6.00	1-6,8,10	967	4.38	1458	6.31	2917	11.16
60	1.20	2.20	2.65	1-2	963	1.15	1453	1.63	2906	2.83
61	1.21	4.12	5.00	1-4	956	3.40	1442	4.88	2884	8.73
62	1.22	3.00	3.65	1-4	953	2.10	1438	3.01	2877	5.39
63	1.23	5.30	6.50	1-6,8,10	946	4.72	1427	6.80	2854	11.97
64	1.23	3.35	4.12	1-4	943	2.52	1423	3.61	2846	6.48
65	1.23	6.50	8.00	1-6,8,10	942	6.04	1422	8.66	2844	14.89
66	1.23	5.60	6.90	1-6,8,10	941	5.06	1420	7.27	2841	12.74
67	1.23	3.65	4.50	1-4	941	2.86	1419	4.12	2839	7.38
68	1.24	4.50	5.60	1-4	932	3.83	1406	5.52	2813	9.83
69	1.26	2.50	3.15	1-3	921	1.53	1389	2.17	2778	3.85
70	1.26	4.75	6.00	1-6,8,10	918	4.12	1385	5.93	2771	10.54
71	1.26	2.65	3.35	1-4	918	1.71	1384	2.43	2769	4.33
72	1.27	2.20	2.80	1-2	911	1.17	1375	1.66	2750	2.89
73	1.28	2.35	3.00	1-2	909	1.35	1371	1.92	2742	3.38
74	1.29	4.12	5.30	1-4	902	3.41	1360	4.91	2721	8.79
75	1.30	5.00	6.50	1-6,8,10	892	4.41	1346	6.35	2692	11.24
76	1.30	3.65	4.75	1-4	891	2.88	1345	4.14	2689	7.43
77	1.30	5.30	6.90	1-6,8,10	891	4.74	1344	6.82	2688	12.03
78	1.30	2.80	3.65	1-4	890	1.89	1342	2.71	2685	4.83
79	1.31	3.15	4.12	1-4	887	2.30	1338	3.30	2676	5.92
80	1.32	10.60	14.00	1-6,8,10	878	10.32	1325	14.50
81	1.33	8.00	10.60	1-6,8,10	875	7.66	1321	10.93
82	1.33	4.50	6.00	1-4	870	3.85	1313	5.55	2625	9.89
83	1.33	6.00	8.00	1-6,8,10	870	5.52	1313	7.93	2625	13.80
84	1.34	2.50	3.35	1-3	866	1.55	1306	2.20	2612	3.90
85	1.34	2.35	3.15	1-2	865	1.37	1306	1.94	2611	3.42
86	1.34	3.35	4.50	1-4	864	2.54	1303	3.65	2606	6.55
87	1.36	4.12	5.60	1-4	853	3.43	1287	4.93	2575	8.83
88	1.36	2.20	3.00	1-2	851	1.19	1283	1.68	2567	2.94
89	1.37	4.75	6.50	1-6,8,10	848	4.14	1279	5.96	2558	10.60
90	1.37	3.65	5.00	1-4	847	2.89	1278	4.16	2555	7.47
91	1.37	3.00	4.12	1-4	845	2.14	1274	3.07	2549	5.49
92	1.38	2.65	3.65	1-4	842	1.73	1271	2.47	2541	4.40
93	1.38	5.00	6.90	1-6,8,10	841	4.42	1268	6.37	2536	11.28
94	1.42	3.35	4.75	1-4	818	2.55	1234	3.67	2468	6.59
95	1.43	2.35	3.35	1-2	814	1.38	1228	1.96	2455	3.46
96	1.43	3.15	4.50	1-4	812	2.32	1225	3.33	2450	5.98
97	1.43	5.60	8.00	1-6,8,10	812	5.10	1225	7.33	2450	12.85
98	1.43	2.20	3.15	1-2	810	1.20	1222	1.70	2444	2.97
99	1.44	4.50	6.50	1-4	803	3.87	1212	5.57	2423	9.94
100	1.45	3.65	5.30	1-4	799	2.90	1205	4.18	2410	7.50

DRIVE SELECTION TABLES



CENTER DISTANCE AND COMBINED ARC-LENGTH CORRECTION FACTOR ▲																LINE #
3VX 280	3VX 315	3VX 355	3VX 400	3VX 450	3VX 500	3VX 560	3VX 600	3VX 710	3VX 750	3VX 800	3VX 900	3VX 1000	3VX 1120	3VX 1250	3VX 1320	
...	10.8	13.3	16.3	18.3	23.8	25.8	28.3	33.3	38.3	44.3	50.8	54.3	51
...	...	8.2	10.5	13.0	15.5	18.5	20.5	26.0	28.0	30.5	35.5	40.5	46.5	53.0	56.5	52
...	8.0	10.0	12.3	14.8	17.3	20.3	22.3	27.8	29.8	32.3	37.3	42.3	48.3	54.8	58.3	53
...	7.6	9.6	11.9	14.4	16.9	19.9	21.9	27.4	29.4	31.9	36.9	41.9	47.9	54.4	57.9	54
9.4	11.2	13.2	15.4	17.9	20.4	23.4	25.4	30.9	32.9	35.4	40.4	45.4	51.4	57.9	61.4	55
■ 0.82	0.84	0.87	0.90	0.92	0.94	0.97	0.98	1.02	1.03	1.05	1.07	1.10	1.12	1.14	1.15	■
10.0	11.7	13.7	16.0	18.5	21.0	24.0	26.0	31.5	33.5	36.0	41.0	46.0	52.0	58.5	62.0	56
9.2	10.9	12.9	15.2	17.7	20.2	23.2	25.2	30.7	32.7	35.2	40.2	45.2	51.2	57.7	61.2	57
9.7	11.4	13.4	15.7	18.2	20.7	23.7	25.7	31.2	33.2	35.7	40.7	45.7	51.7	58.2	61.7	58
...	...	9.1	11.3	13.9	16.4	19.4	21.4	26.9	28.9	31.4	36.4	41.4	47.4	53.9	57.4	59
10.2	11.9	13.9	16.2	18.7	21.2	24.2	26.2	31.7	33.7	36.2	41.2	46.2	52.2	58.7	62.2	60
■ 0.82	0.85	0.87	0.90	0.92	0.95	0.97	0.99	1.02	1.03	1.05	1.07	1.10	1.12	1.14	1.16	■
6.8	8.6	10.6	12.8	15.3	17.8	20.8	22.8	28.3	30.3	32.8	37.8	42.8	48.8	55.3	58.8	61
8.8	10.5	12.5	14.8	17.3	19.8	22.8	24.8	30.3	32.3	34.8	39.8	44.8	50.8	57.3	60.8	62
...	...	8.5	10.7	13.2	15.7	18.7	20.7	26.2	28.2	30.7	35.7	40.7	46.7	53.2	56.7	63
8.1	9.9	11.9	14.1	16.6	19.1	22.1	24.1	29.6	31.6	34.1	39.1	44.1	50.1	56.6	60.1	64
...	11.1	13.6	16.6	18.6	24.1	26.1	28.6	33.6	38.6	44.6	51.1	54.6	65
■ 0.82	0.84	0.87	0.90	0.92	0.94	0.97	0.98	1.02	1.03	1.05	1.07	1.09	1.12	1.14	1.15	■
...	10.2	12.7	15.2	18.2	20.2	25.7	27.7	30.2	35.2	40.2	46.2	52.7	56.2	66
7.6	9.3	11.3	13.6	16.1	18.6	21.6	23.6	29.1	31.1	33.6	38.6	43.6	49.6	56.1	59.6	67
...	7.8	9.8	12.1	14.6	17.1	20.1	22.1	27.6	29.6	32.1	37.1	42.1	48.1	54.6	58.1	68
9.6	11.3	13.3	15.6	18.1	20.6	23.6	25.6	31.1	33.1	35.6	40.6	45.6	51.6	58.1	61.6	69
...	7.3	9.3	11.5	14.0	16.5	19.5	21.5	27.0	29.1	31.6	36.6	41.6	47.6	54.1	57.6	70
■ 0.82	0.84	0.87	0.89	0.92	0.94	0.97	0.98	1.02	1.03	1.05	1.07	1.09	1.12	1.14	1.15	■
9.3	11.0	13.0	15.3	17.8	20.3	23.3	25.3	30.8	32.8	35.3	40.3	45.3	51.3	57.8	61.3	71
10.1	11.8	13.8	16.1	18.6	21.1	24.1	26.1	31.6	33.6	36.1	41.1	46.1	52.1	58.6	62.1	72
9.8	11.5	13.5	15.8	18.3	20.8	23.8	25.8	31.3	33.3	35.8	40.8	45.8	51.8	58.3	61.8	73
6.6	8.3	10.3	12.6	15.1	17.6	20.6	22.6	28.1	30.1	32.6	37.6	42.6	48.6	55.1	58.6	74
...	...	8.7	10.9	13.4	16.0	19.0	21.0	26.5	28.5	31.0	36.0	41.0	47.0	53.5	57.0	75
■ 0.82	0.84	0.87	0.90	0.92	0.94	0.97	0.98	1.02	1.03	1.05	1.07	1.09	1.12	1.14	1.15	■
7.4	9.1	11.1	13.4	15.9	18.4	21.4	23.4	28.9	30.9	33.4	38.4	43.4	49.4	55.9	59.4	76
...	...	8.1	10.4	12.9	15.4	18.4	20.4	25.9	27.9	30.4	35.4	40.4	46.4	52.9	56.4	77
8.9	10.7	12.7	14.9	17.4	19.9	22.9	24.9	30.4	32.4	34.9	39.9	44.9	50.9	57.4	60.9	78
8.3	10.0	12.0	14.3	16.8	19.3	22.3	24.3	29.8	31.8	34.3	39.3	44.3	50.3	56.8	60.3	79
...	16.1	18.1	20.6	25.6	30.6	36.6	43.1	46.6	80
■ 0.82	0.84	0.87	0.89	0.92	0.94	0.97	0.98	1.02	1.03	1.04	1.07	1.09	1.12	1.14	1.15	■
...	13.3	15.3	20.9	22.9	25.4	30.4	35.4	41.4	47.9	51.4	81
...	7.5	9.5	11.7	14.2	16.7	19.7	21.7	27.2	29.2	31.7	36.7	41.7	47.7	54.2	57.7	82
...	8.9	11.5	14.0	17.0	19.0	24.5	26.5	29.0	34.0	39.0	45.0	51.5	55.0	83
9.4	11.1	13.1	15.4	17.9	20.4	23.4	25.4	30.9	32.9	35.4	40.4	45.4	51.4	57.9	61.4	84
9.7	11.4	13.4	15.7	18.2	20.7	23.7	25.7	31.2	33.2	35.7	40.7	45.7	51.7	58.2	61.7	85
■ 0.82	0.84	0.87	0.89	0.92	0.94	0.96	0.98	1.02	1.03	1.04	1.07	1.09	1.12	1.14	1.15	■
7.8	9.6	11.6	13.8	16.3	18.8	21.8	23.8	29.3	31.3	33.8	38.8	43.8	49.8	56.3	59.8	86
...	8.1	10.1	12.3	14.8	17.4	20.4	22.4	27.9	29.9	32.4	37.4	42.4	48.4	54.9	58.4	87
9.9	11.7	13.7	15.9	18.4	20.9	23.9	25.9	31.4	33.4	35.9	40.9	45.9	51.9	58.4	61.9	88
...	...	8.9	11.1	13.6	16.1	19.1	21.1	26.6	28.6	31.2	36.2	41.2	47.2	53.7	57.2	89
7.2	8.9	10.9	13.2	15.7	18.2	21.2	23.2	28.7	30.7	33.2	38.2	43.2	49.2	55.7	59.2	90
■ 0.81	0.84	0.86	0.89	0.92	0.94	0.97	0.98	1.02	1.03	1.05	1.07	1.09	1.12	1.14	1.15	■
8.4	10.1	12.1	14.4	16.9	19.4	22.4	24.4	29.9	31.9	34.4	39.4	44.4	50.4	56.9	60.4	91
9.0	10.8	12.8	15.0	17.5	20.0	23.0	25.0	30.5	32.5	35.0	40.0	45.0	51.0	57.5	61.0	92
...	...	8.3	10.6	13.1	15.6	18.6	20.6	26.1	28.1	30.6	35.6	40.6	46.6	53.1	56.6	93
7.6	9.4	11.4	13.6	16.1	18.6	21.6	23.6	29.1	31.1	33.6	38.6	43.6	49.6	56.1	59.6	94
9.5	11.3	13.3	15.5	18.0	20.5	23.5	25.5	31.0	33.0	35.5	40.5	45.5	51.5	58.0	61.5	95
■ 0.81	0.84	0.86	0.89	0.92	0.94	0.97	0.98	1.02	1.03	1.05	1.07	1.09	1.12	1.14	1.15	■
8.0	9.7	11.7	14.0	16.5	19.0	22.0	24.0	29.5	31.5	34.0	39.0	44.0	50.0	56.5	60.0	96
...	9.2	11.8	14.3	17.3	19.3	24.8	26.8	29.3	34.3	39.3	45.3	51.8	55.3	97
9.8	11.5	13.5	15.8	18.3	20.8	23.8	25.8	31.3	33.3	35.8	40.8	45.8	51.8	58.3	61.8	98
...	...	9.1	11.3	13.8	16.3	19.3	21.3	26.8	28.8	31.3	36.3	41.3	47.4	53.9	57.4	99
6.9	8.7	10.7	12.9	15.4	18.0	21.0	23.0	28.5	30.5	33.0	38.0	43.0	49.0	55.5	59.0	100
■ 0.81	0.84	0.86	0.89	0.91	0.94	0.96	0.98	1.02	1.03	1.04	1.07	1.09	1.12	1.14	1.15	■

▲ Not all available belt lengths are shown.

■ Combined Arc-Length correction factors for 5 preceding lines.



3VX BELTS IN 3V SHEAVES

LINE #	RATIO	STOCK SHEAVES			DRIVEN SPEEDS AND HORSEPOWER RATINGS PER BELT					
		Datum Diameter		Number Grooves	1160 RPM		1750 RPM		3500 RPM	
		DR	DN		Driven Speed	H.P. Ratings	Driven Speed	H.P. Ratings	Driven Speed	H.P. Ratings
101	1.45	4.75	6.90	1-6,8,10	799	4.15	1205	5.98	2409	10.64
102	1.46	4.12	6.00	1-4	797	3.44	1202	4.95	2403	8.87
103	1.46	2.50	3.65	1-3	795	1.56	1199	2.22	2397	3.95
104	1.47	2.80	4.12	1-4	788	1.92	1189	2.74	2379	4.91
105	1.49	3.35	5.00	1-4	777	2.56	1173	3.68	2345	6.61
106	1.50	3.00	4.50	1-4	773	2.15	1167	3.09	2333	5.54
107	1.51	3.15	4.75	1-4	769	2.33	1161	3.34	2321	6.01
108	1.51	5.30	8.00	1-6,8,10	769	4.77	1159	6.87	2319	12.11
109	1.52	2.20	3.35	1-2	762	1.21	1149	1.71	2299	3.00
110	1.53	4.50	6.90	1-4	757	3.88	1141	5.59	2283	9.97
111	1.53	3.65	5.60	1-4	756	2.91	1141	4.19	2281	7.52
112	1.54	6.90	10.60	1-6,8,10	755	6.52	1139	9.34	2278	15.92
113	1.55	2.35	3.65	1-2	747	1.39	1127	1.98	2253	3.50
114	1.55	2.65	4.12	1-4	746	1.75	1126	2.50	2251	4.46
115	1.58	4.12	6.50	1-4	735	3.45	1109	4.97	2218	8.91
116	1.58	3.35	5.30	1-4	733	2.57	1106	3.69	2212	6.63
117	1.58	3.00	4.75	1-4	733	2.16	1105	3.10	2211	5.56
118	1.59	3.15	5.00	1-4	731	2.34	1103	3.35	2205	6.02
119	1.60	5.00	8.00	1-6,8,10	725	4.45	1094	6.40	2188	11.35
120	1.61	2.80	4.50	1-4	722	1.93	1089	2.76	2178	4.94
121	1.63	6.50	10.60	1-6,8,10	711	6.10	1073	8.75	2146	15.06
122	1.64	3.65	6.00	1-4	706	2.92	1065	4.20	2129	7.55
123	1.65	2.50	4.12	1-3	704	1.58	1062	2.25	2124	4.00
124	1.66	2.20	3.65	1-2	699	1.22	1055	1.73	2110	3.03
125	1.67	3.00	5.00	1-4	696	2.17	1050	3.11	2100	5.58
126	1.67	3.35	5.60	1-4	694	2.57	1047	3.70	2094	6.65
127	1.67	4.12	6.90	1-4	693	3.46	1045	4.98	2090	8.92
128	1.68	3.15	5.30	1-4	689	2.34	1040	3.36	2080	6.04
129	1.68	4.75	8.00	1-6,8,10	689	4.17	1039	6.01	2078	10.69
130	1.70	2.80	4.75	1-4	684	1.93	1032	2.77	2063	4.96
131	1.70	2.65	4.50	1-4	683	1.76	1031	2.51	2061	4.48
132	1.75	8.00	14.00	1-6,8,10	663	7.70	1000	10.99
133	1.75	2.35	4.12	1-2	662	1.40	998	1.99	1996	3.53
134	1.77	3.00	5.30	1-4	657	2.17	991	3.11	1981	5.59
135	1.77	6.00	10.60	1-6,8,10	657	5.56	991	7.99	1981	13.91
136	1.78	3.15	5.60	1-4	653	2.35	984	3.37	1969	6.05
137	1.78	4.50	8.00	1-4	653	3.89	984	5.61	1969	10.01
138	1.78	3.65	6.50	1-4	651	2.93	983	4.21	1965	7.57
139	1.79	2.80	5.00	1-4	650	1.94	980	2.77	1960	4.97
140	1.79	3.35	6.00	1-4	648	2.58	977	3.71	1954	6.67
141	1.79	2.65	4.75	1-4	647	1.76	976	2.52	1953	4.50
142	1.79	10.60	19.00	1-6,8,10	647	10.36	976	14.56
143	1.80	2.50	4.50	1-3	644	1.58	972	2.26	1944	4.02
144	1.87	3.00	5.60	1-4	621	2.17	938	3.12	1875	5.60
145	1.87	2.20	4.12	1-2	619	1.23	934	1.74	1869	3.06
146	1.89	2.65	5.00	1-4	615	1.76	928	2.52	1855	4.50
147	1.89	3.65	6.90	1-4	614	2.93	926	4.21	1851	7.58
148	1.89	2.80	5.30	1-4	613	1.94	925	2.78	1849	4.98
149	1.89	5.60	10.60	1-6,8,10	613	5.12	925	7.37	1849	12.94
150	1.90	2.50	4.75	1-3	611	1.59	921	2.26	1842	4.03

DRIVE SELECTION TABLES



CENTER DISTANCE AND COMBINED ARC-LENGTH CORRECTION FACTOR ▲																LINE #
3VX 250	3VX 280	3VX 315	3VX 355	3VX 400	3VX 450	3VX 500	3VX 560	3VX 600	3VX 710	3VX 750	3VX 800	3VX 900	3VX 1000	3VX 1120	3VX 1250	
...	8.5	10.8	13.3	15.8	18.8	20.8	26.3	28.3	30.8	35.8	40.8	46.8	53.3	101
...	...	7.7	9.8	12.0	14.5	17.0	20.0	22.0	27.5	29.5	32.0	37.0	42.0	48.0	54.5	102
7.6	9.2	10.9	12.9	15.2	17.7	20.2	23.2	25.2	30.7	32.7	35.2	40.2	45.2	51.2	57.7	103
7.0	8.5	10.3	12.3	14.6	17.1	19.6	22.6	24.6	30.1	32.1	34.6	39.6	44.6	50.6	57.1	104
...	7.4	9.2	11.2	13.4	15.9	18.4	21.4	23.4	28.9	30.9	33.4	38.4	43.4	49.4	55.9	105
■ 0.79	0.81	0.83	0.86	0.89	0.92	0.94	0.97	0.98	1.02	1.03	1.04	1.07	1.09	1.12	1.14	106
6.6	8.1	9.8	11.8	14.1	16.6	19.1	22.1	24.1	29.6	31.6	34.1	39.1	44.1	50.1	56.6	106
6.2	7.8	9.5	11.5	13.8	16.3	18.8	21.8	23.8	29.3	31.3	33.8	38.8	43.8	49.8	56.3	107
...	9.5	12.0	14.5	17.5	19.5	25.0	27.0	29.5	34.5	39.5	45.5	52.0	108
8.1	9.6	11.4	13.4	15.6	18.1	20.6	23.6	25.6	31.1	33.1	35.6	40.6	45.6	51.6	58.1	109
...	8.7	11.0	13.5	16.0	19.0	21.0	26.5	28.5	31.0	36.0	41.0	47.0	53.5	110
■ 0.78	0.81	0.84	0.86	0.88	0.91	0.94	0.96	0.98	1.02	1.03	1.04	1.07	1.09	1.12	1.14	111
...	6.7	8.4	10.4	12.7	15.2	17.7	20.7	22.7	28.2	30.2	32.7	37.7	42.7	48.7	55.2	111
...	11.1	14.1	16.1	21.7	23.7	26.2	31.2	36.2	42.2	48.7	112
7.8	9.3	11.0	13.0	15.3	17.8	20.3	23.3	25.3	30.8	32.8	35.3	40.3	45.3	51.3	57.8	113
7.1	8.7	10.4	12.4	14.7	17.2	19.7	22.7	24.7	30.2	32.2	34.7	39.7	44.7	50.7	57.2	114
...	...	7.3	9.3	11.6	14.1	16.6	19.6	21.6	27.1	29.1	31.6	36.6	41.6	47.6	54.1	115
■ 0.78	0.81	0.83	0.86	0.89	0.91	0.93	0.96	0.98	1.01	1.03	1.04	1.07	1.09	1.12	1.14	116
...	7.1	8.9	10.9	13.2	15.7	18.2	21.2	23.2	28.7	30.7	33.2	38.2	43.2	49.2	55.7	116
6.4	7.9	9.6	11.6	13.9	16.4	18.9	21.9	23.9	29.4	31.4	33.9	38.9	43.9	49.9	56.4	117
6.0	7.5	9.3	11.3	13.6	16.1	18.6	21.6	23.6	29.1	31.1	33.6	38.6	43.6	49.6	56.1	118
...	9.7	12.2	14.7	17.7	19.7	25.2	27.2	29.8	34.8	39.8	45.8	52.3	119
6.7	8.2	10.0	12.0	14.2	16.7	19.2	22.3	24.3	29.8	31.8	34.3	39.3	44.3	50.3	56.8	120
■ 0.77	0.80	0.83	0.86	0.88	0.91	0.94	0.96	0.98	1.02	1.03	1.04	1.07	1.09	1.12	1.14	121
...	11.4	14.4	16.4	22.0	24.0	26.5	31.5	36.5	42.5	49.0	121
...	...	8.1	10.1	12.4	14.9	17.4	20.4	22.4	27.9	29.9	32.4	37.4	42.4	48.4	54.9	122
7.3	8.8	10.5	12.5	14.8	17.3	19.8	22.8	24.8	30.3	32.3	34.8	39.8	44.8	50.8	57.3	123
7.9	9.4	11.1	13.1	15.4	17.9	20.4	23.4	25.4	30.9	32.9	35.4	40.4	45.4	51.4	57.9	124
6.1	7.7	9.4	11.4	13.7	16.2	18.7	21.7	23.7	29.2	31.2	33.7	38.7	43.7	49.7	56.2	125
■ 0.78	0.81	0.83	0.86	0.89	0.91	0.93	0.96	0.97	1.01	1.03	1.04	1.07	1.09	1.11	1.14	126
...	6.9	8.6	10.7	12.9	15.4	17.9	20.9	22.9	28.4	30.4	33.0	38.0	43.0	49.0	55.5	126
...	9.0	11.3	13.8	16.3	19.3	21.3	26.8	28.8	31.3	36.3	41.3	47.3	53.8	127
...	7.3	9.0	11.1	13.3	15.8	18.3	21.3	23.3	28.8	30.8	33.3	38.3	43.4	49.4	55.9	128
...	9.9	12.4	14.9	17.9	19.9	25.4	27.4	29.9	34.9	40.0	46.0	52.5	129
6.5	8.0	9.8	11.8	14.0	16.5	19.0	22.0	24.1	29.6	31.6	34.1	39.1	44.1	50.1	56.6	130
■ 0.77	0.80	0.83	0.85	0.88	0.91	0.93	0.96	0.98	1.01	1.03	1.04	1.07	1.09	1.11	1.14	131
6.8	8.3	10.1	12.1	14.4	16.9	19.4	22.4	24.4	29.9	31.9	34.4	39.4	44.4	50.4	56.9	131
...	18.0	20.0	22.5	27.6	32.6	38.6	45.1	132
7.4	8.9	10.6	12.6	14.9	17.4	19.9	22.9	24.9	30.4	32.4	34.9	39.9	44.9	50.9	57.4	133
...	7.4	9.2	11.2	13.4	15.9	18.4	21.5	23.5	29.0	31.0	33.5	38.5	43.5	49.5	56.0	134
...	11.7	14.8	16.8	22.3	24.4	26.9	31.9	36.9	42.9	49.4	135
■ 0.78	0.80	0.83	0.86	0.89	0.91	0.93	0.96	0.97	1.00	1.02	1.03	1.06	1.09	1.11	1.14	136
...	7.0	8.8	10.8	13.1	15.6	18.1	21.1	23.1	28.6	30.6	33.1	38.1	43.1	49.1	55.6	136
...	10.0	12.6	15.1	18.1	20.1	25.6	27.6	30.1	35.1	40.1	46.1	52.7	137
...	...	7.6	9.7	11.9	14.5	17.0	20.0	22.0	27.5	29.5	32.0	37.0	42.0	48.0	54.5	138
6.3	7.8	9.6	11.6	13.8	16.3	18.8	21.8	23.8	29.4	31.4	33.9	38.9	43.9	49.9	56.4	139
...	6.5	8.3	10.3	12.6	15.1	17.6	20.6	22.6	28.1	30.1	32.6	37.6	42.6	48.6	55.1	140
■ 0.76	0.79	0.82	0.85	0.88	0.91	0.93	0.96	0.97	1.01	1.02	1.04	1.07	1.09	1.11	1.14	141
6.6	8.1	9.9	11.9	14.1	16.7	19.2	22.2	24.2	29.7	31.7	34.2	39.2	44.2	50.2	56.7	141
...	21.3	26.4	32.5	39.0	142
6.9	8.4	10.2	12.2	14.5	17.0	19.5	22.5	24.5	30.0	32.0	34.5	39.5	44.5	50.5	57.0	143
...	7.1	8.9	10.9	13.2	15.7	18.2	21.2	23.2	28.7	30.7	33.2	38.2	43.2	49.2	55.7	144
7.5	9.0	10.7	12.8	15.0	17.5	20.0	23.0	25.0	30.5	32.5	35.0	40.0	45.0	51.0	57.5	145
■ 0.77	0.80	0.83	0.86	0.89	0.91	0.94	0.96	0.98	1.02	1.03	1.04	1.06	1.08	1.11	1.13	146
6.4	7.9	9.7	11.7	13.9	16.4	19.0	22.0	24.0	29.5	31.5	34.0	39.0	44.0	50.0	56.5	146
...	...	7.3	9.3	11.6	14.1	16.6	19.6	21.7	27.2	29.2	31.7	36.7	41.7	47.7	54.2	147
6.0	7.5	9.3	11.3	13.6	16.1	18.6	21.6	23.6	29.1	31.1	33.6	38.6	43.6	49.6	56.1	148
...	12.0	15.1	17.1	22.6	24.6	27.2	32.2	37.2	43.2	49.7	149
6.7	8.2	10.0	12.0	14.3	16.8	19.3	22.3	24.3	29.8	31.8	34.3	39.3	44.3	50.3	56.8	150
■ 0.76	0.79	0.82	0.85	0.88	0.91	0.93	0.95	0.97	1.01	1.02	1.04	1.06	1.09	1.11	1.14	150

▲ Not all available belt lengths are shown.

■ Combined Arc-Length correction factors for 5 preceding lines.



3VX BELTS IN 3V SHEAVES

LINE #	RATIO	STOCK SHEAVES			DRIVEN SPEEDS AND HORSEPOWER RATINGS PER BELT					
		Datum Diameter		Number Grooves	1160 RPM		1750 RPM		3500 RPM	
		DR	DN		Driven Speed	H.P. Ratings	Driven Speed	H.P. Ratings	Driven Speed	H.P. Ratings
151	1.90	3.15	6.00	1-4	609	2.35	919	3.37	1838	6.07
152	1.91	2.35	4.50	1-2	606	1.41	914	2.00	1828	3.55
153	1.94	3.35	6.50	1-4	598	2.58	902	3.71	1804	6.68
154	1.94	4.12	8.00	1-4	597	3.47	901	4.99	1802	8.95
155	2.00	2.50	5.00	1-3	580	1.59	875	2.27	1750	4.03
156	2.00	2.65	5.30	1-4	580	1.77	875	2.52	1750	4.51
157	2.00	2.80	5.60	1-4	580	1.94	875	2.78	1750	4.99
158	2.00	3.00	6.00	1-4	580	2.18	875	3.12	1750	5.61
159	2.00	5.30	10.60	1-6,8,10	580	4.80	875	6.90	1750	12.18
160	2.02	2.35	4.75	1-2	574	1.41	866	2.01	1732	3.55
161	2.03	6.90	14.00	1-6,8,10	572	6.54	863	9.38	1725	15.98
162	2.05	2.20	4.50	1-2	567	1.23	856	1.75	1711	3.07
163	2.06	3.35	6.90	1-4	563	2.59	850	3.72	1699	6.69
164	2.06	3.15	6.50	1-4	562	2.35	848	3.38	1696	6.08
165	2.11	2.65	5.60	1-4	549	1.77	828	2.53	1656	4.52
166	2.12	2.50	5.30	1-3	547	1.59	825	2.27	1651	4.04
167	2.12	5.00	10.60	1-6,8,10	547	4.46	825	6.43	1651	11.40
168	2.13	2.35	5.00	1-2	545	1.41	823	2.01	1645	3.56
169	2.14	2.80	6.00	1-4	541	1.95	817	2.79	1633	4.99
170	2.15	6.50	14.00	1-6,8,10	539	6.11	812	8.77	1625	15.11
171	2.16	2.20	4.75	1-2	537	1.23	811	1.75	1621	3.07
172	2.17	3.00	6.50	1-4	535	2.18	808	3.13	1615	5.62
173	2.19	3.15	6.90	1-4	530	2.36	799	3.38	1598	6.08
174	2.19	3.65	8.00	1-4	529	2.93	798	4.22	1597	7.59
175	2.23	4.75	10.60	1-6,8,10	520	4.19	784	6.03	1568	10.73
176	2.24	2.50	5.60	1-3	518	1.59	781	2.27	1563	4.05
177	2.26	2.35	5.30	1-2	514	1.42	776	2.01	1552	3.56
178	2.26	2.65	6.00	1-4	512	1.77	773	2.53	1546	4.53
179	2.27	2.20	5.00	1-2	510	1.24	770	1.75	1540	3.08
180	2.30	3.00	6.90	1-4	504	2.18	761	3.13	1522	5.62
181	2.32	2.80	6.50	1-4	500	1.95	754	2.79	1508	5.00
182	2.33	6.00	14.00	1-6,8,10	497	5.57	750	8.01	1500	13.95
183	2.36	4.50	10.60	1-4	492	3.91	743	5.63	1486	10.05
184	2.36	10.60	25.00	2-6,8,10	492	10.38	742	14.58
185	2.38	8.00	19.00	1-6,8,10	488	7.72	737	11.01
186	2.38	2.35	5.60	1-2	487	1.42	734	2.01	1469	3.57
187	2.39	3.35	8.00	1-4	486	2.59	733	3.72	1466	6.70
188	2.40	2.50	6.00	1-3	483	1.59	729	2.27	1458	4.05
189	2.41	2.20	5.30	1-2	482	1.24	726	1.75	1453	3.08
190	2.45	2.65	6.50	1-4	473	1.77	713	2.53	1427	4.53
191	2.46	2.80	6.90	1-4	471	1.95	710	2.79	1420	5.00
192	2.50	5.60	14.00	1-6,8,10	464	5.13	700	7.38	1400	12.97
193	2.54	3.15	8.00	1-4	457	2.36	689	3.39	1378	6.09
194	2.55	2.20	5.60	1-2	456	1.24	688	1.75	1375	3.09
195	2.55	2.35	6.00	1-2	454	1.42	685	2.02	1371	3.57
196	2.57	4.12	10.60	1-4	451	3.48	680	5.01	1360	8.98
197	2.60	2.50	6.50	1-3	446	1.60	673	2.28	1346	4.06
198	2.60	2.65	6.90	1-4	446	1.77	672	2.54	1344	4.53
199	2.64	5.30	14.00	1-6,8,10	439	4.80	663	6.91	1325	12.20
200	2.67	3.00	8.00	1-4	435	2.19	656	3.14	1313	5.63

DRIVE SELECTION TABLES



CENTER DISTANCE AND COMBINED ARC-LENGTH CORRECTION FACTOR ▲																LINE #
3VX 250	3VX 280	3VX 315	3VX 355	3VX 400	3VX 450	3VX 500	3VX 560	3VX 600	3VX 710	3VX 750	3VX 800	3VX 900	3VX 1000	3VX 1120	3VX 1250	
...	6.7	8.4	10.5	12.7	15.2	17.8	20.8	22.8	28.3	30.3	32.8	37.8	42.8	48.8	55.3	151
7.0	8.6	10.3	12.3	14.6	17.1	19.6	22.6	24.6	30.1	32.1	34.6	39.6	44.6	50.6	57.1	152
...	...	7.9	9.9	12.2	14.7	17.2	20.2	22.2	27.7	29.7	32.2	37.2	42.2	48.2	54.7	153
...	8.0	10.3	12.8	15.4	18.4	20.4	25.9	27.9	30.4	35.4	40.4	46.4	52.9	154
6.5	8.0	9.8	11.8	14.1	16.6	19.1	22.1	24.1	29.6	31.6	34.1	39.1	44.1	50.1	56.6	155
■ 0.77	0.79	0.82	0.84	0.87	0.90	0.93	0.96	0.97	1.01	1.02	1.04	1.06	1.09	1.11	1.14	156
6.1	7.6	9.4	11.4	13.7	16.2	18.7	21.7	23.7	29.2	31.2	33.7	38.7	43.7	49.7	56.2	157
...	7.3	9.0	11.1	13.3	15.8	18.3	21.4	23.4	28.9	30.9	33.4	38.4	43.4	49.4	55.9	158
...	6.8	8.5	10.6	12.8	15.4	17.9	20.9	22.9	28.4	30.4	32.9	37.9	42.9	48.9	55.4	158
...	12.2	15.3	17.3	22.9	24.9	27.4	32.4	37.4	43.4	49.9	159
6.8	8.3	10.1	12.1	14.4	16.9	19.4	22.4	24.4	29.9	31.9	34.4	39.4	44.4	50.4	56.9	160
■ 0.76	0.79	0.82	0.85	0.88	0.91	0.92	0.95	0.97	1.01	1.02	1.04	1.06	1.09	1.11	1.14	161
...	13.1	18.7	20.8	23.3	28.4	33.4	39.4	45.9	161
7.1	8.7	10.4	12.4	14.7	17.2	19.7	22.7	24.7	30.2	32.2	34.7	39.7	44.7	50.7	57.2	162
...	...	7.5	9.5	11.8	14.3	16.9	19.9	21.9	27.4	29.4	31.9	36.9	41.9	47.9	54.4	163
...	...	8.0	10.0	12.3	14.8	17.3	20.4	22.4	27.9	29.9	32.4	37.4	42.4	48.4	54.9	164
...	7.4	9.2	11.2	13.4	16.0	18.5	21.5	23.5	29.0	31.0	33.5	38.5	43.5	49.5	56.0	165
■ 0.77	0.79	0.81	0.84	0.87	0.90	0.93	0.96	0.96	1.00	1.02	1.03	1.06	1.08	1.11	1.13	166
6.2	7.7	9.5	11.5	13.8	16.3	18.8	21.8	23.8	29.3	31.3	33.8	38.8	43.9	49.9	56.4	166
...	9.8	12.4	15.5	17.5	23.1	25.1	27.6	32.6	37.6	43.7	50.2	167	
6.6	8.1	9.9	11.9	14.2	16.7	19.2	22.2	24.2	29.7	31.7	34.2	39.2	44.2	50.2	56.7	168
...	6.9	8.7	10.7	13.0	15.5	18.0	21.0	23.0	28.5	30.5	33.0	38.1	43.1	49.1	55.6	169
...	13.4	19.0	21.1	23.6	28.7	33.7	39.7	46.2	170
■ 0.75	0.78	0.82	0.85	0.88	0.89	0.92	0.95	0.95	1.00	1.01	1.03	1.06	1.08	1.11	1.13	171
6.9	8.4	10.2	12.2	14.5	17.0	19.5	22.5	24.5	30.0	32.0	34.5	39.5	44.5	50.5	57.0	171
...	...	8.1	10.1	12.4	14.9	17.5	20.5	22.5	28.0	30.0	32.5	37.5	42.5	48.5	55.0	172
...	...	7.6	9.7	12.0	14.5	17.0	20.0	22.0	27.5	29.5	32.1	37.1	42.1	48.1	54.6	173
...	8.3	10.6	13.2	15.7	18.7	20.7	26.3	28.3	30.8	35.8	40.8	46.8	53.3	174
...	10.0	12.6	15.7	17.7	23.3	25.3	27.8	32.8	37.8	43.8	50.4	175	
■ 0.76	0.79	0.81	0.83	0.87	0.89	0.92	0.95	0.96	1.00	1.02	1.03	1.06	1.08	1.11	1.13	176
5.9	7.5	9.3	11.3	13.5	16.1	18.6	21.6	23.6	29.1	31.1	33.6	38.6	43.6	49.6	56.1	176
6.3	7.9	9.6	11.6	13.9	16.4	18.9	21.9	23.9	29.5	31.5	34.0	39.0	44.0	50.0	56.5	177
...	7.0	8.8	10.8	13.1	15.6	18.1	21.1	23.1	28.7	30.7	33.2	38.2	43.2	49.2	55.7	178
6.7	8.2	10.0	12.0	14.3	16.8	19.3	22.3	24.3	29.8	31.8	34.3	39.3	44.3	50.3	56.8	179
...	...	7.7	9.8	12.1	14.6	17.1	20.1	22.1	27.7	29.7	32.2	37.2	42.2	48.2	54.7	180
■ 0.75	0.78	0.81	0.84	0.87	0.90	0.93	0.96	0.97	1.01	1.02	1.04	1.06	1.09	1.11	1.14	181
...	6.4	8.2	10.3	12.6	15.1	17.6	20.6	22.6	28.1	30.1	32.6	37.7	42.7	48.7	55.2	181
...	13.7	19.4	21.4	24.0	29.0	34.1	40.1	46.6	182
...	10.2	12.8	15.8	17.9	23.4	25.5	28.0	33.0	38.0	44.0	50.5	183	
...	20.8	27.1	33.8	184
...	15.3	18.0	23.1	28.3	34.4	40.9	185
■	0.76	0.80	0.83	0.87	0.87	0.90	0.94	0.94	0.99	0.98	1.00	1.04	1.05	1.08	1.11	186
6.0	7.6	9.4	11.4	13.7	16.2	18.7	21.7	23.7	29.2	31.2	33.7	38.7	43.7	49.7	56.2	186
...	8.5	10.8	13.4	15.9	18.9	21.0	26.5	28.5	31.0	36.0	41.0	47.0	53.5	187
...	7.1	8.9	10.9	13.2	15.7	18.2	21.3	23.3	28.8	30.8	33.3	38.3	43.3	49.3	55.8	188
6.4	8.0	9.7	11.8	14.0	16.5	19.0	22.1	24.1	29.6	31.6	34.1	39.1	44.1	50.1	56.6	189
...	6.5	8.3	10.4	12.7	15.2	17.7	20.7	22.7	28.2	30.3	32.8	37.8	42.8	48.8	55.3	190
■ 0.74	0.77	0.81	0.83	0.87	0.90	0.92	0.95	0.97	1.01	1.02	1.04	1.06	1.09	1.11	1.14	191
...	...	7.9	9.9	12.2	14.7	17.3	20.3	22.3	27.8	29.8	32.3	37.3	42.3	48.3	54.8	191
...	11.9	14.0	19.7	21.7	24.2	29.3	34.3	40.4	46.9	192
...	8.7	11.0	13.5	16.1	19.1	21.1	26.6	28.6	31.1	36.2	41.2	47.2	53.7	193
6.1	7.7	9.5	11.5	13.8	16.3	18.8	21.8	23.8	29.3	31.3	33.8	38.8	43.8	49.8	56.3	194
...	7.2	9.0	11.0	13.3	15.8	18.4	21.4	23.4	28.9	30.9	33.4	38.4	43.4	49.4	55.9	195
■ 0.74	0.77	0.80	0.83	0.86	0.89	0.92	0.93	0.95	1.00	1.01	1.03	1.06	1.08	1.11	1.13	196
...	10.4	13.0	16.1	18.1	23.7	25.7	28.3	33.3	38.3	44.3	50.8	196	
...	6.6	8.4	10.5	12.8	15.3	17.8	20.8	22.8	28.4	30.4	32.9	37.9	42.9	48.9	55.4	197
...	...	8.0	10.0	12.3	14.8	17.4	20.4	22.4	27.9	29.9	32.4	37.4	42.4	48.5	55.0	198
...	12.1	14.2	19.9	21.9	24.5	29.5	34.6	40.6	47.1	199
...	8.8	11.1	13.6	16.2	19.2	21.2	26.7	28.8	31.3	36.3	41.3	47.3	53.8	200
■	0.75	0.79	0.82	0.86	0.88	0.91	0.92	0.95	0.99	1.01	1.02	1.05	1.08	1.10	1.13	200

▲ Not all available belt lengths are shown.
 ■ Combined Arc-Length correction factors for 5 preceding lines.



3VX BELTS IN 3V SHEAVES

LINE #	RATIO	STOCK SHEAVES			DRIVEN SPEEDS AND HORSEPOWER RATINGS PER BELT					
		Datum Diameter		Number Grooves	1160 RPM		1750 RPM		3500 RPM	
		DR	DN		Driven Speed	H.P. Ratings	Driven Speed	H.P. Ratings	Driven Speed	H.P. Ratings
201	2.73	2.20	6.00	1-2	425	1.24	642	1.76	1283	3.09
202	2.75	6.90	19.00	1-6,8,10	421	6.55	636	9.39	1271	16.01
203	2.76	2.50	6.90	1-3	420	1.60	634	2.28	1268	4.06
204	2.77	2.35	6.50	1-2	419	1.42	633	2.02	1265	3.58
205	2.80	5.00	14.00	1-6,8,10	414	4.47	625	6.44	1250	11.42
206	2.86	2.80	8.00	1-4	406	1.95	613	2.80	1225	5.01
207	2.90	3.65	10.60	1-4	399	2.94	603	4.23	1205	7.61
208	2.92	6.50	19.00	1-6,8,10	397	6.12	599	8.78	1197	15.13
209	2.94	2.35	6.90	1-2	395	1.42	596	2.02	1192	3.58
210	2.95	4.75	14.00	1-6,8,10	394	4.19	594	6.04	1188	10.75
211	2.95	2.20	6.50	1-2	393	1.24	592	1.76	1185	3.09
212	3.02	2.65	8.00	1-4	384	1.78	580	2.54	1159	4.54
213	3.11	4.50	14.00	1-4	373	3.91	563	5.63	1125	10.06
214	3.11	10.60	33.00	3-6,8,10	373	10.38	562	14.59
215	3.13	8.00	25.00	2-6,8,10	371	7.72	560	11.01
216	3.14	2.20	6.90	1-2	370	1.24	558	1.76	1116	3.09
217	3.16	3.35	10.60	1-4	367	2.59	553	3.73	1106	6.71
218	3.17	6.00	19.00	1-6,8,10	366	5.58	553	8.01	1105	13.96
219	3.20	2.50	8.00	1-3	363	1.60	547	2.28	1094	4.06
220	3.37	3.15	10.60	1-4	345	2.36	520	3.39	1040	6.10
221	3.39	5.60	19.00	1-6,8,10	342	5.14	516	7.39	1032	12.98
222	3.40	4.12	14.00	1-4	341	3.48	515	5.01	1030	8.99
223	3.40	2.35	8.00	1-2	341	1.42	514	2.02	1028	3.58
224	3.53	3.00	10.60	1-4	328	2.19	495	3.14	991	5.64
225	3.58	5.30	19.00	1-6,8,10	324	4.81	488	6.92	976	12.21
226	3.62	6.90	25.00	2-6,8,10	320	6.55	483	9.39	966	16.01
227	3.64	2.20	8.00	1-2	319	1.24	481	1.76	963	3.10
228	3.79	2.80	10.60	1-4	306	1.95	462	2.80	925	5.02
229	3.80	5.00	19.00	1-6,8,10	305	4.47	461	6.44	921	11.43
230	3.84	3.65	14.00	1-4	302	2.94	456	4.23	913	7.62
231	3.85	6.50	25.00	2-6,8,10	302	6.12	455	8.79	910	15.13
232	4.00	2.65	10.60	1-4	290	1.78	438	2.54	875	4.55
233	4.00	4.75	19.00	1-6,8,10	290	4.19	438	6.04	875	10.75
234	4.13	8.00	33.00	3-6,8,10	281	7.72	424	11.02
235	4.17	6.00	25.00	2-6,8,10	278	5.58	420	8.02	840	13.97
236	4.18	3.35	14.00	1-4	278	2.60	419	3.73	837	6.72
237	4.22	4.50	19.00	1-4	275	3.91	414	5.63	829	10.07
238	4.24	2.50	10.60	1-3	274	1.60	413	2.28	825	4.07
239	4.44	3.15	14.00	1-4	261	2.36	394	3.40	788	6.11
240	4.46	5.60	25.00	2-6,8,10	260	5.14	392	7.39	784	12.98
241	4.51	2.35	10.60	1-2	257	1.42	388	2.02	776	3.59
242	4.61	4.12	19.00	1-4	252	3.48	379	5.01	759	8.99
243	4.67	3.00	14.00	1-4	249	2.19	375	3.14	750	5.65
244	4.72	5.30	25.00	2-6,8,10	246	4.81	371	6.92	742	12.22
245	4.78	6.90	33.00	3-6,8,10	243	6.55	366	9.39	732	16.02
246	4.82	2.20	10.60	1-2	241	1.24	363	1.76	726	3.10
247	5.00	2.80	14.00	1-4	232	1.96	350	2.80	700	5.02
248	5.00	5.00	25.00	2-6,8,10	232	4.47	350	6.44	700	11.43
249	5.08	6.50	33.00	3-6,8,10	228	6.12	345	8.79	689	15.14
250	5.21	3.65	19.00	1-4	223	2.94	336	4.24	672	7.62

DRIVE SELECTION TABLES



CENTER DISTANCE AND COMBINED ARC-LENGTH CORRECTION FACTOR ▲																LINE #	
3VX 280	3VX 315	3VX 355	3VX 400	3VX 450	3VX 500	3VX 560	3VX 600	3VX 710	3VX 750	3VX 800	3VX 900	3VX 1000	3VX 1120	3VX 1250	3VX 1320		
7.3	9.1	11.1	13.4	15.9	18.5	21.5	23.5	29.0	31.0	33.5	38.5	43.5	49.5	56.0	59.5	201	
...	16.0	18.7	23.9	29.0	35.1	41.7	202	
...	8.1	10.1	12.4	15.0	17.5	20.5	22.5	28.0	30.0	32.5	37.6	42.6	48.6	55.1	58.6	203	
6.7	8.5	10.6	12.9	15.4	17.9	20.9	23.0	28.5	30.5	33.0	38.0	43.0	49.0	55.5	59.0	204	
...	12.3	14.4	20.1	22.1	24.7	29.7	34.8	40.8	47.4	50.9	205	
■ 0.76	0.79	0.83	0.86	0.89	0.92	0.93	0.95	0.99	0.99	1.01	1.04	1.07	1.10	1.12	1.14	■	206
...	...	8.9	11.2	13.8	16.3	19.3	21.4	26.9	28.9	31.4	36.4	41.4	47.4	54.0	57.5	207	
...	10.7	13.4	16.4	18.5	24.1	26.1	28.6	33.6	38.7	44.7	51.2	54.7	208	
...	16.3	18.9	24.2	29.3	35.4	42.0	45.5	209		
...	8.2	10.2	12.5	15.1	17.6	20.6	22.6	28.1	30.1	32.7	37.7	42.7	48.7	55.2	58.7	210	
...	12.4	14.5	20.2	22.3	24.8	29.9	35.0	41.0	47.5	51.1	210	
■	0.78	0.81	0.85	0.87	0.90	0.91	0.94	0.99	0.98	1.00	1.04	1.06	1.09	1.12	1.13	■	211
6.8	8.6	10.7	13.0	15.5	18.0	21.1	23.1	28.6	30.6	33.1	38.1	43.1	49.1	55.6	59.1	212	
...	...	9.0	11.3	13.9	16.4	19.5	21.5	27.0	29.0	31.5	36.5	41.5	47.6	54.1	57.6	213	
...	12.6	14.7	20.4	22.5	25.0	30.1	35.1	41.2	47.7	51.2	214	
...	25.8	29.6	215	
...	22.5	28.8	35.6	39.2	215	
■ 0.75	0.79	0.81	0.85	0.89	0.91	0.91	0.94	0.99	1.00	1.02	1.05	1.05	1.08	1.08	1.10	■	216
6.4	8.3	10.3	12.6	15.2	17.7	20.7	22.7	28.3	30.3	32.8	37.8	42.8	48.8	55.3	58.8	217	
...	10.9	13.6	16.6	18.7	24.3	26.3	28.8	33.8	38.9	44.9	51.4	54.9	218	
...	14.4	16.6	19.3	24.5	29.7	35.8	42.4	45.9	219	
...	...	9.1	11.4	14.0	16.5	19.6	21.6	27.1	29.1	31.6	36.7	41.7	47.7	54.2	57.7	220	
...	11.1	13.7	16.8	18.8	24.4	26.4	29.0	34.0	39.0	45.0	51.6	55.1	220	
■ 0.73	0.78	0.81	0.85	0.86	0.89	0.93	0.95	0.97	0.99	1.00	1.04	1.07	1.09	1.12	1.13	■	221
...	14.6	16.8	19.5	24.8	29.9	36.1	42.7	46.2	222	
...	12.8	15.0	20.7	22.7	25.3	30.4	35.4	41.5	48.0	51.5	223	
...	7.1	9.2	11.5	14.1	16.6	19.7	21.7	27.2	29.2	31.7	36.8	41.8	47.8	54.3	57.8	224	
...	11.2	13.8	16.9	18.9	24.5	26.5	29.1	34.1	39.1	45.2	51.7	55.2	225	
...	14.8	17.0	19.7	25.0	30.1	36.3	42.9	46.4	225	
■	0.74	0.80	0.84	0.85	0.89	0.90	0.93	0.93	0.96	0.98	1.02	1.05	1.08	1.11	1.12	■	226
...	23.2	29.6	36.3	39.9	227	
...	7.2	9.3	11.6	14.2	16.7	19.8	21.8	27.3	29.3	31.9	36.9	41.9	47.9	54.4	57.9	228	
...	8.6	11.3	13.9	17.0	19.1	24.7	26.7	29.2	34.3	39.3	45.3	51.8	55.3	229	
...	15.0	17.2	19.9	25.2	30.3	36.5	43.1	46.6	230	
...	13.1	15.3	21.0	23.1	25.6	30.7	35.8	41.8	48.4	51.9	230	
■	0.74	0.79	0.80	0.85	0.89	0.90	0.92	0.95	0.97	0.99	1.03	1.04	1.07	1.10	1.12	■	231
...	17.9	23.4	29.8	36.6	40.2	232	
...	8.7	11.4	14.0	17.1	19.2	24.8	26.8	29.3	34.4	39.4	45.4	51.9	55.5	233	
...	15.2	17.4	20.1	25.3	30.5	36.7	43.3	46.8	234	
...	27.5	31.3	235	
...	18.2	23.8	30.2	36.9	40.5	235	
■			0.76	0.83	0.87	0.91	0.93	0.92	0.95	0.97	0.94	1.00	1.05	1.06	1.08	■	236
...	13.3	15.5	21.2	23.3	25.8	30.9	36.0	42.0	48.6	52.1	237	
...	15.3	17.5	20.2	25.5	30.7	36.8	43.4	47.0	238	
...	8.8	11.5	14.1	17.2	19.3	24.9	26.9	29.4	34.5	39.5	45.5	52.1	55.6	239	
...	13.4	15.6	21.3	23.4	26.0	31.1	36.1	42.2	48.7	52.2	240	
...	18.4	24.0	30.4	37.2	40.8	240	
■			0.76	0.83	0.87	0.87	0.90	0.93	0.96	0.98	0.99	1.03	1.07	1.10	1.11	■	241
...	8.9	11.6	14.2	17.3	19.4	25.0	27.0	29.5	34.6	39.6	45.6	52.2	55.7	242	
...	15.6	17.8	20.5	25.8	30.9	37.1	43.7	47.3	243	
...	13.5	15.7	21.4	23.5	26.1	31.2	36.2	42.3	48.8	52.4	244	
...	18.6	24.2	30.6	37.4	41.0	245	
...	28.1	32.0	245	
■			0.76	0.82	0.87	0.88	0.90	0.93	0.95	0.98	0.98	1.02	1.06	1.07	1.09	■	246
...	9.0	11.7	14.3	17.4	19.5	25.1	27.1	29.6	34.7	39.7	45.8	52.3	55.8	247	
...	10.3	13.7	15.8	21.6	23.6	26.2	31.3	36.4	42.4	49.0	52.5	248	
...	18.8	24.4	30.8	37.6	41.2	249	
...	28.4	32.3	249	
...	15.9	18.1	20.8	26.1	31.3	37.4	44.0	47.6	250	
■			0.76	0.82	0.81	0.87	0.90	0.93	0.95	0.97	0.98	1.02	1.06	1.07	1.09	■	250

▲ Not all available belt lengths are shown.
 ■ Combined Arc-Length correction factors for 5 preceding lines.



3VX BELTS IN 3V SHEAVES

LINE #	RATIO	STOCK SHEAVES			DRIVEN SPEEDS AND HORSEPOWER RATINGS PER BELT					
		Datum Diameter		Number Grooves	1160 RPM		1750 RPM		3500 RPM	
		DR	DN		Driven Speed	H.P. Ratings	Driven Speed	H.P. Ratings	Driven Speed	H.P. Ratings
251	5.26	4.75	25.00	2-6,8,10	220	4.19	333	6.04	665	10.76
252	5.28	2.65	14.00	1-4	220	1.78	331	2.54	663	4.55
253	5.50	6.00	33.00	3-6,8,10	211	5.58	318	8.02	636	13.97
254	5.56	4.50	25.00	2-4	209	3.91	315	5.64	630	10.07
255	5.60	2.50	14.00	1-3	207	1.60	313	2.28	625	4.07
256	5.67	3.35	19.00	1-4	205	2.60	309	3.73	617	6.72
257	5.89	5.60	33.00	3-6,8,10	197	5.14	297	7.39	594	12.99
258	5.96	2.35	14.00	1-2	195	1.42	294	2.02	588	3.59
259	6.03	3.15	19.00	1-4	192	2.37	290	3.40	580	6.11
260	6.07	4.12	25.00	2-4	191	3.48	288	5.02	577	9.00
261	6.23	5.30	33.00	3-6,8,10	186	4.81	281	6.92	562	12.22
262	6.33	3.00	19.00	1-4	183	2.19	276	3.14	553	5.65
263	6.36	2.20	14.00	1-2	182	1.24	275	1.76	550	3.10
264	6.60	5.00	33.00	3-6,8,10	176	4.47	265	6.44	530	11.43
265	6.79	2.80	19.00	1-4	171	1.96	258	2.80	516	5.02
266	6.85	3.65	25.00	2-4	169	2.94	256	4.24	511	7.62
267	6.95	4.75	33.00	3-6,8,10	167	4.19	252	6.04	504	10.76
268	7.17	2.65	19.00	1-4	162	1.78	244	2.54	488	4.55
269	7.33	4.50	33.00	3-4	158	3.91	239	5.64	477	10.07
270	7.46	3.35	25.00	2-4	155	2.60	234	3.74	469	6.72
271	7.60	2.50	19.00	1-3	153	1.60	230	2.29	461	4.07
272	7.94	3.15	25.00	2-4	146	2.37	221	3.40	441	6.11
273	8.01	4.12	33.00	3-4	145	3.48	218	5.02	437	9.00
274	8.09	2.35	19.00	1-2	143	1.42	216	2.03	433	3.59
275	8.33	3.00	25.00	2-4	139	2.19	210	3.14	420	5.65
276	8.64	2.20	19.00	1-2	134	1.24	203	1.76	405	3.11
277	8.93	2.80	25.00	2-4	130	1.96	196	2.80	392	5.03
278	9.04	3.65	33.00	3-4	128	2.94	194	4.24	387	7.62
279	9.43	2.65	25.00	2-4	123	1.78	186	2.54	371	4.55
280	9.85	3.35	33.00	3-4	118	2.60	178	3.74	355	6.72
281	10.00	2.50	25.00	2-3	116	1.60	175	2.29	350	4.07
282	10.48	3.15	33.00	3-4	111	2.37	167	3.40	334	6.11
283	10.64	2.35	25.00	2-2	109	1.42	165	2.03	329	3.59
284	11.00	3.00	33.00	3-4	105	2.19	159	3.14	318	5.65
285	11.36	2.20	25.00	2-2	102	1.25	154	1.76	308	3.11
286	11.79	2.80	33.00	3-4	98	1.96	148	2.80	297	5.03
287	12.45	2.65	33.00	3-4	93	1.78	141	2.54	281	4.55
288	13.20	2.50	33.00	3-3	88	1.60	133	2.29	265	4.08
289	14.04	2.35	33.00	3-2	83	1.42	125	2.03	249	3.59
290	15.00	2.20	33.00	3-2	77	1.25	117	1.76	233	3.11

DRIVE SELECTION TABLES



CENTER DISTANCE AND COMBINED ARC-LENGTH CORRECTION FACTOR ▲												LINE #
3VX 500	3VX 560	3VX 600	3VX 710	3VX 750	3VX 800	3VX 900	3VX 1000	3VX 1120	3VX 1250	3VX 1320	3VX 1400	
...	18.9	24.5	31.0	37.8	41.4	45.5	251
10.4	13.8	15.9	21.7	23.7	26.3	31.4	36.5	42.5	49.1	52.6	56.6	252
...	28.7	32.6	36.9	253
...	19.1	24.7	31.1	37.9	41.6	45.7	254
10.5	13.8	16.0	21.8	23.8	26.4	31.5	36.6	42.7	49.2	52.7	56.7	255
■ 0.76	0.84	0.88	0.95	0.96	0.98	0.94	1.00	1.04	1.06	1.08	1.10	■
...	16.0	18.3	21.0	26.3	31.5	37.6	44.3	47.8	51.9	256
...	21.3	28.9	32.8	37.2	257
10.6	13.9	16.1	21.9	24.0	26.5	31.6	36.7	42.8	49.3	52.8	56.9	258
...	16.2	18.4	21.1	26.4	31.6	37.8	44.4	47.9	52.0	259
...	19.3	24.9	31.4	38.2	41.8	45.9	260
■ 0.76	0.84	0.88	0.88	0.91	0.94	0.96	1.01	1.00	1.06	1.08	1.10	■
...	21.4	29.1	33.0	37.4	261
...	16.3	18.5	21.2	26.5	31.7	37.9	44.5	48.1	52.1	262
10.6	14.0	16.2	22.0	24.1	26.6	31.7	36.8	42.9	49.4	52.9	57.0	263
...	21.6	29.3	33.2	37.5	264
...	16.4	18.6	21.3	26.6	31.8	38.0	44.6	48.2	52.3	265
■ 0.75	0.84	0.87	0.88	0.91	0.94	0.99	1.03	0.97	1.04	1.06	1.09	■
...	19.6	25.2	31.7	38.5	42.1	46.3	266
...	21.8	29.5	33.4	37.7	267
...	16.5	18.7	21.4	26.7	32.0	38.1	44.7	48.3	52.4	268
...	21.9	29.6	33.5	37.9	269
...	19.8	25.4	31.9	38.7	42.4	46.5	270
■			0.85	0.88	0.92	0.90	0.97	0.94	1.02	1.05	1.07	■
...	16.6	18.8	21.5	26.8	32.1	38.2	44.9	48.4	52.5	271
...	19.9	25.6	32.0	38.9	42.5	46.6	272
...	22.1	29.9	33.8	38.1	273
...	16.7	18.9	21.6	26.9	32.2	38.3	45.0	48.5	52.6	274
...	20.0	25.7	32.1	39.0	42.6	46.7	275
■			0.84	0.88	0.92	0.92	0.98	0.99	1.04	1.07	1.09	■
...	16.7	19.0	21.7	27.0	32.3	38.4	45.1	48.6	52.7	276
...	20.1	25.8	32.3	39.1	42.7	46.9	277
...	22.4	30.1	34.1	38.4	278
...	20.2	25.9	32.4	39.2	42.8	47.0	279
...	22.6	30.3	34.2	38.6	280
■			0.84	0.88	0.92	0.89	0.96	0.94	1.02	1.04	1.07	■
...	20.3	26.0	32.5	39.3	42.9	47.1	281
...	22.7	30.5	34.4	38.7	282
...	20.4	26.1	32.5	39.4	43.0	47.2	283
...	22.8	30.5	34.5	38.8	284
...	20.5	26.2	32.6	39.5	43.1	47.3	285
■						0.85	0.94	0.93	1.01	1.03	1.06	■
...	22.9	30.7	34.6	39.0	286
...	23.0	30.8	34.7	39.1	287
...	23.1	30.8	34.8	39.1	288
...	23.2	30.9	34.9	39.2	289
...	23.3	31.0	35.0	39.3	290
■								0.81	0.95	0.99	1.02	■

▲ Not all available belt lengths are shown.

■ Combined Arc-Length correction factors for 5 preceding lines.



5VX & 5V BELTS IN 5V SHEAVES

LINE #	RATIO	STOCK SHEAVES			DRIVEN SPEEDS AND HORSEPOWER RATINGS PER BELT								
		Datum Diameter		Number Grooves	1160 RPM			1750 RPM			3500 RPM		
		DR	DN		Driven Speed	H.P. Ratings		Driven Speed	H.P. Ratings		Driven Speed	H.P. Ratings	
						5VX	5V		5VX	5V		5VX	5V
1	1.00	4.40	4.40	2-6	1160	6.22	3.41	1750	8.70	4.36	3500	14.39	4.95
2	1.00	4.65	4.65	2-6	1160	7.03	4.20	1750	9.86	5.49	3500	16.42	6.79
3	1.00	4.90	4.90	2-6	1160	7.83	4.99	1750	11.02	6.61	3500	18.41	8.59
4	1.00	5.20	5.20	2-6	1160	8.78	5.93	1750	12.39	7.94	3500	20.76	10.67
5	1.00	5.50	5.50	2-6	1160	9.73	6.86	1750	13.75	9.25	3500	23.05	12.67
6	1.00	5.90	5.90	2-6	1160	10.99	8.09	1750	15.56	10.98	3500	26.01	15.19
7	1.00	6.30	6.30	2-6	1160	12.24	9.31	1750	17.34	12.69	3500	28.87	17.56
8	1.00	6.70	6.70	2-6	1160	13.48	10.52	1750	19.10	14.36	3500	31.62	19.75
9	1.00	7.10	7.10	2-10	1160	14.71	11.71	1750	20.84	16.01	3500	34.25	21.77
10	1.00	7.50	7.50	2-10	1160	15.93	12.90	1750	22.56	17.62
11	1.00	8.00	8.00	2-10	1160	17.45	14.36	1750	24.68	19.60
12	1.00	8.50	8.50	2-10	1160	18.95	15.81	1750	26.77	21.53
13	1.00	9.00	9.00	2-10	1160	20.44	17.24	1750	28.82	23.41
14	1.00	9.25	9.25	2-10	1160	21.18	17.94	1750	29.83	24.33
15	1.00	9.75	9.75	2-10	1160	22.65	19.34	1750	31.83	26.13
16	1.00	10.30	10.30	2-10	1160	24.25	20.86	1750	33.99	28.04
17	1.00	10.90	10.90	2-10	1160	25.97	22.49	1750	36.29	30.06
18	1.00	11.30	11.30	2-10	1160	27.11	23.56	1750	37.79	31.35
19	1.00	11.80	11.80	2-10	1160	28.52	24.87	1750	39.63	32.91
20	1.00	12.50	12.50	2-10	1160	30.47	26.68	1750	42.14	34.99
21	1.00	13.20	13.20	2-10	1160	32.39	28.45	1750	44.56	36.94
22	1.00	14.00	14.00	2-10	1160	34.55	30.41	1750	47.22	39.00
23	1.00	15.00	15.00	2-10	1160	37.19	32.78
24	1.00	16.00	16.00	2-10	1160	39.76	35.05
25	1.00	18.70	18.70	2-10	1160	46.36	40.66
26	1.03	9.00	9.25	2-10	1129	20.56	17.39	1703	29.00	23.64
27	1.04	10.90	11.30	2-10	1119	26.12	22.69	1688	36.52	30.35
28	1.04	11.30	11.80	2-10	1111	27.29	23.79	1676	38.06	31.70
29	1.05	4.65	4.90	2-6	1101	7.24	4.48	1661	10.18	5.90	3321	17.06	7.63
30	1.05	9.25	9.75	2-10	1101	21.39	18.22	1660	30.16	24.75
31	1.06	12.50	13.20	2-10	1098	30.69	26.97	1657	42.47	35.42
32	1.06	7.10	7.50	2-10	1098	14.93	12.00	1657	21.18	16.44	3313	34.92	22.64
33	1.06	9.75	10.30	2-10	1098	22.87	19.63	1657	32.17	26.56
34	1.06	4.40	4.65	2-6	1098	6.45	3.70	1656	9.03	4.79	3312	15.06	5.82
35	1.06	5.20	5.50	2-6	1097	9.01	6.22	1655	12.73	8.38	3309	21.44	11.56
36	1.06	10.30	10.90	2-10	1096	24.48	21.16	1654	34.33	28.49
37	1.06	8.50	9.00	2-10	1096	19.18	16.11	1653	27.12	21.98
38	1.06	11.80	12.50	2-10	1095	28.75	25.18	1652	39.98	33.36
39	1.06	6.70	7.10	2-6	1095	13.71	10.82	1651	19.45	14.82	3303	32.32	20.67
40	1.06	13.20	14.00	2-10	1094	32.63	28.76	1650	44.91	37.40
41	1.06	4.90	5.20	2-6	1093	8.06	5.30	1649	11.37	7.07	3298	19.13	9.52
42	1.06	8.00	8.50	2-10	1092	17.69	14.68	1647	25.05	20.08
43	1.06	6.30	6.70	2-6	1091	12.49	9.63	1646	17.71	13.17	3291	29.61	18.52
44	1.07	7.50	8.00	2-10	1088	16.19	13.23	1641	22.95	18.13
45	1.07	15.00	16.00	2-10	1088	37.44	33.11
46	1.07	5.90	6.30	2-6	1086	11.25	8.43	1639	15.95	11.49	3278	26.80	16.21
47	1.07	14.00	15.00	2-10	1083	34.82	30.76	1633	47.63	39.53
48	1.07	5.50	5.90	2-6	1081	10.01	7.22	1631	14.17	9.79	3263	23.88	13.75
49	1.08	10.90	11.80	2-10	1072	26.28	22.89	1617	36.75	30.65
50	1.08	9.00	9.75	2-10	1071	20.75	17.64	1615	29.29	24.01

Shaded area diameters are below industry standard for belt.

DRIVE SELECTION TABLES



CENTER DISTANCE AND COMBINED ARC-LENGTH CORRECTION FACTOR ▲																LINE #
5VX 500	5VX 530	5VX 560	5VX 630	5VX 710	5VX 750	5VX 800	5VX 900	5VX 1000	5VX 1250	5VX 1400	5VX 1500	5VX 1600	5VX 1800	5VX 1900	5VX 2000	
18.1	19.6	21.1	24.6	28.6	30.6	33.1	38.1	43.1	55.6	63.1	68.1	73.1	83.1	88.1	93.1	1
17.7	19.2	20.7	24.2	28.2	30.2	32.7	37.7	42.7	55.2	62.7	67.7	72.7	82.7	87.7	92.7	2
17.3	18.8	20.3	23.8	27.8	29.8	32.3	37.3	42.3	54.8	62.3	67.3	72.3	82.3	87.3	92.3	3
16.8	18.3	19.8	23.3	27.3	29.3	31.8	36.8	41.8	54.3	61.8	66.8	71.8	81.8	86.8	91.8	4
16.4	17.9	19.4	22.9	26.9	28.9	31.4	36.4	41.4	53.9	61.4	66.4	71.4	81.4	86.4	91.4	5
■ 0.83	0.84	0.85	0.87	0.90	0.91	0.92	0.94	0.96	1.00	1.02	1.03	1.05	1.07	1.08	1.09	6
15.7	17.2	18.7	22.2	26.2	28.2	30.7	35.7	40.7	53.2	60.7	65.7	70.7	80.7	85.7	90.7	7
15.1	16.6	18.1	21.6	25.6	27.6	30.1	35.1	40.1	52.6	60.1	65.1	70.1	80.1	85.1	90.1	8
14.5	16.0	17.5	21.0	25.0	27.0	29.5	34.5	39.5	52.0	59.5	64.5	69.5	79.5	84.5	89.5	9
13.8	15.3	16.8	20.3	24.3	26.3	28.8	33.8	38.8	51.3	58.8	63.8	68.8	78.8	83.8	88.8	10
13.2	14.7	16.2	19.7	23.7	25.7	28.2	33.2	38.2	50.7	58.2	63.2	68.2	78.2	83.2	88.2	10
■ 0.83	0.84	0.85	0.87	0.90	0.91	0.92	0.94	0.96	1.00	1.02	1.03	1.05	1.07	1.08	1.09	11
12.4	13.9	15.4	18.9	22.9	24.9	27.4	32.4	37.4	49.9	57.4	62.4	67.4	77.4	82.4	87.4	12
11.6	13.1	14.6	18.1	22.1	24.1	26.6	31.6	36.6	49.1	56.6	61.6	66.6	76.6	81.6	86.6	13
...	12.4	13.9	17.4	21.4	23.4	25.9	30.9	35.9	48.4	55.9	60.9	65.9	75.9	80.9	85.9	14
...	12.0	13.5	17.0	21.0	23.0	25.5	30.5	35.5	48.0	55.5	60.5	65.5	75.5	80.5	85.5	15
...	...	12.7	16.2	20.2	22.2	24.7	29.7	34.7	47.2	54.7	59.7	64.7	74.7	79.7	84.7	16
■ 0.83	0.84	0.85	0.87	0.90	0.91	0.92	0.94	0.96	1.00	1.02	1.03	1.05	1.07	1.08	1.09	17
...	15.3	19.3	21.3	23.8	28.8	33.8	46.3	53.8	58.8	63.8	73.8	78.8	83.8	18
...	14.4	18.4	20.4	22.9	27.9	32.9	45.4	52.9	57.9	62.9	72.9	77.9	82.9	19
...	17.7	19.7	22.2	27.2	32.2	44.7	52.2	57.2	62.2	72.2	77.2	82.2	20
...	17.0	19.0	21.5	26.5	31.5	44.0	51.5	56.5	61.5	71.5	76.5	81.5	21
...	15.9	17.9	20.4	25.4	30.4	42.9	50.4	55.4	60.4	70.4	75.4	80.4	22
■			0.87	0.90	0.91	0.92	0.94	0.96	1.00	1.02	1.03	1.05	1.07	1.08	1.09	23
...	16.8	19.3	24.3	29.3	41.8	49.3	54.3	59.3	69.3	74.3	79.3	24
...	18.0	23.0	28.0	40.5	48.0	53.0	58.0	68.0	73.0	78.0	25
...	21.4	26.4	31.4	36.4	46.4	51.4	56.4	26
...	19.9	24.9	29.9	34.9	44.9	49.9	54.9	27
...	33.1	40.6	45.6	50.6	60.6	65.6	28
■					0.91	0.92	0.94	0.96	1.00	1.02	1.03	1.05	1.07	1.08	1.09	29
...	12.2	13.7	17.2	21.2	23.2	25.7	30.7	35.7	48.2	55.7	60.7	65.7	75.7	80.7	85.7	30
...	14.1	18.1	20.1	22.6	27.6	32.6	45.1	52.6	57.6	62.6	72.6	77.6	82.6	31
...	17.4	19.4	21.9	26.9	31.9	44.4	51.9	56.9	61.9	71.9	76.9	81.9	32
17.5	19.0	20.5	24.0	28.0	30.0	32.5	37.5	42.5	55.0	62.5	67.5	72.5	82.5	87.5	92.5	33
...	...	13.1	16.6	20.6	22.6	25.1	30.1	35.1	47.6	55.1	60.1	65.1	75.1	80.1	85.1	34
■ 0.83	0.84	0.85	0.87	0.89	0.90	0.92	0.94	0.96	1.00	1.02	1.03	1.05	1.07	1.08	1.09	35
...	17.3	19.8	24.8	29.8	42.3	49.8	54.8	59.8	69.8	74.8	79.8	36
13.5	15.0	16.5	20.0	24.0	26.0	28.5	33.5	38.5	51.0	58.5	63.5	68.5	78.5	83.5	88.5	37
...	15.8	19.8	21.8	24.3	29.3	34.3	46.8	54.3	59.3	64.3	74.3	79.3	84.3	38
17.9	19.4	20.9	24.4	28.4	30.4	32.9	37.9	42.9	55.4	62.9	67.9	72.9	82.9	87.9	92.9	39
16.6	18.1	19.6	23.1	27.1	29.1	31.6	36.6	41.6	54.1	61.6	66.6	71.6	81.6	86.6	91.6	40
■ 0.83	0.84	0.85	0.87	0.89	0.90	0.92	0.94	0.96	1.00	1.02	1.03	1.04	1.07	1.08	1.09	41
...	14.8	18.8	20.8	23.3	28.3	33.3	45.8	53.3	58.3	63.3	73.3	78.3	83.3	42
11.3	12.8	14.3	17.8	21.8	23.8	26.3	31.3	36.3	48.8	56.3	61.3	66.3	76.3	81.3	86.3	43
...	16.4	18.4	20.9	25.9	30.9	43.4	50.9	55.9	60.9	70.9	75.9	80.9	44
14.2	15.7	17.2	20.7	24.7	26.7	29.2	34.2	39.2	51.7	59.2	64.2	69.2	79.2	84.2	89.2	45
...	16.1	18.6	23.6	28.6	41.1	48.6	53.6	58.6	68.6	73.6	78.6	46
■ 0.83	0.84	0.85	0.87	0.89	0.90	0.91	0.94	0.96	1.00	1.02	1.03	1.04	1.07	1.08	1.09	47
17.1	18.6	20.1	23.6	27.6	29.6	32.1	37.1	42.1	54.6	62.1	67.1	72.1	82.1	87.1	92.1	48
12.0	13.5	15.0	18.5	22.5	24.5	27.0	32.0	37.0	49.5	57.0	62.0	67.0	77.0	82.0	87.0	49
14.8	16.3	17.8	21.3	25.3	27.3	29.8	34.8	39.8	52.3	59.8	64.8	69.8	79.8	84.8	89.8	50
12.8	14.3	15.8	19.3	23.3	25.3	27.8	32.8	37.8	50.3	57.8	62.8	67.8	77.8	82.8	87.8	51
...	20.6	25.6	38.1	45.6	50.6	55.6	65.6	70.6	75.6	52
■ 0.83	0.84	0.85	0.87	0.89	0.90	0.91	0.94	0.96	1.00	1.02	1.03	1.04	1.07	1.08	1.09	53
15.4	16.9	18.4	21.9	25.9	27.9	30.4	35.4	40.4	52.9	60.4	65.4	70.4	80.4	85.4	90.4	54
...	17.2	22.2	34.7	42.2	47.2	52.2	62.2	67.2	72.2	55
16.0	17.5	19.0	22.5	26.5	28.5	31.0	36.0	41.0	53.5	61.0	66.0	71.0	81.0	86.0	91.0	56
...	17.7	19.7	22.2	27.2	32.2	44.7	52.2	57.2	62.2	72.2	77.2	82.2	57
...	...	13.3	16.8	20.8	22.8	25.3	30.3	35.3	47.8	55.3	60.3	65.3	75.3	80.3	85.3	58
■ 0.83	0.84	0.85	0.87	0.89	0.90	0.91	0.94	0.96	1.00	1.02	1.03	1.04	1.07	1.08	1.09	59

▲ Not all available belt lengths are shown.

■ Combined Arc-Length correction factors for 5 preceding lines.



5VX & 5V BELTS IN 5V SHEAVES

LINE #	RATIO	STOCK SHEAVES			DRIVEN SPEEDS AND HORSEPOWER RATINGS PER BELT								
		Datum Diameter		Number Grooves	1160 RPM			1750 RPM			3500 RPM		
		DR	DN		Driven Speed	H.P. Ratings		Driven Speed	H.P. Ratings		Driven Speed	H.P. Ratings	
						5VX	5V		5VX	5V		5VX	5V
51	1.09	8.50	9.25	2-10	1066	19.27	16.23	1608	27.25	22.16
52	1.10	10.30	11.30	2-10	1057	24.59	21.31	1595	34.51	28.73
53	1.11	11.30	12.50	2-10	1049	27.48	24.04	1582	38.35	32.08
54	1.11	9.25	10.30	2-10	1042	21.57	18.45	1572	30.42	25.10
55	1.11	4.40	4.90	2-6	1042	6.61	3.92	1571	9.29	5.12	3143	15.57	6.48
56	1.12	9.75	10.90	2-10	1038	23.05	19.87	1565	32.44	26.92
57	1.12	4.65	5.20	2-6	1037	7.43	4.73	1565	10.47	6.28	3130	17.64	8.38
58	1.12	11.80	13.20	2-10	1037	28.92	25.40	1564	40.24	33.70
59	1.12	6.70	7.50	2-6	1036	13.89	11.04	1563	19.71	15.16	3127	32.84	21.35
60	1.12	12.50	14.00	2-10	1036	30.88	27.21	1563	42.75	35.79
61	1.12	4.90	5.50	2-6	1033	8.24	5.53	1559	11.64	7.42	3118	19.66	10.21
62	1.13	8.00	9.00	2-10	1031	17.87	14.91	1556	25.31	20.42
63	1.13	7.10	8.00	2-10	1030	15.14	12.26	1553	21.48	16.84	3106	35.53	23.43
64	1.13	6.30	7.10	2-6	1029	12.66	9.86	1553	17.98	13.52	3106	30.15	19.22
65	1.13	7.50	8.50	2-10	1024	16.37	13.47	1544	23.22	18.49
66	1.13	18.70	21.20	2-10	1023	46.80	41.23
67	1.13	5.20	5.90	2-6	1022	9.22	6.50	1542	13.06	8.81	3085	22.09	12.40
68	1.14	5.90	6.70	2-6	1021	11.44	8.67	1541	16.23	11.86	3082	27.35	16.94
69	1.14	13.20	15.00	2-10	1021	32.84	29.03	1540	45.23	37.81
70	1.14	14.00	16.00	2-10	1015	35.01	31.01	1531	47.91	39.90
71	1.14	9.00	10.30	2-10	1014	20.91	17.84	1529	29.52	24.32
72	1.15	5.50	6.30	2-6	1013	10.20	7.47	1528	14.46	10.17	3056	24.46	14.50
73	1.15	10.30	11.80	2-10	1013	24.71	21.47	1528	34.69	28.96
74	1.15	10.90	12.50	2-10	1012	26.44	23.10	1526	37.00	30.98
75	1.15	8.50	9.75	2-10	1011	19.42	16.42	1526	27.48	22.45
76	1.16	8.00	9.25	2-10	1003	17.94	15.00	1514	25.42	20.56
77	1.16	9.75	11.30	2-10	1001	23.14	19.99	1510	32.58	27.10
78	1.17	11.30	13.20	2-10	993	27.62	24.23	1498	38.56	32.36
79	1.17	16.00	18.70	2-10	993	40.27	35.72
80	1.18	9.25	10.90	2-10	984	21.71	18.64	1485	30.64	25.38
81	1.18	4.40	5.20	2-6	982	6.76	4.11	1481	9.51	5.42	2962	16.02	7.07
82	1.18	4.65	5.50	2-6	981	7.57	4.91	1480	10.68	6.55	2959	18.05	8.92
83	1.19	11.80	14.00	2-10	978	29.07	25.59	1475	40.46	33.99
84	1.19	6.30	7.50	2-6	974	12.80	10.03	1470	18.18	13.78	2940	30.55	19.74
85	1.19	6.70	8.00	2-6	971	14.04	11.25	1466	19.95	15.46	2931	33.31	21.96
86	1.20	7.10	8.50	2-10	969	15.28	12.45	1462	21.70	17.12	2924	35.96	24.00
87	1.20	7.50	9.00	2-10	967	16.51	13.64	1458	23.42	18.75
88	1.20	12.50	15.00	2-10	967	31.04	27.43	1458	43.00	36.11
89	1.20	5.90	7.10	2-6	964	11.57	8.84	1454	16.43	12.12	2908	27.76	17.46
90	1.20	4.90	5.90	2-6	963	8.41	5.74	1453	11.89	7.74	2907	20.16	10.86
91	1.21	9.75	11.80	2-10	958	23.24	20.11	1446	32.72	27.28
92	1.21	10.90	13.20	2-10	958	26.56	23.26	1445	37.18	31.21
93	1.21	9.00	10.90	2-10	958	21.03	18.01	1445	29.71	24.57
94	1.21	5.20	6.30	2-6	957	9.37	6.70	1444	13.28	9.10	2889	22.54	12.99
95	1.21	8.50	10.30	2-10	957	19.54	16.58	1444	27.66	22.69
96	1.21	13.20	16.00	2-10	957	32.98	29.22	1444	45.45	38.10
97	1.21	10.30	12.50	2-10	956	24.84	21.63	1442	34.89	29.21
89	1.22	5.50	6.70	2-6	952	10.33	7.64	1437	14.66	10.43	2873	24.86	15.03
99	1.22	8.00	9.75	2-10	952	18.05	15.15	1436	25.59	20.78
100	1.22	9.25	11.30	2-10	950	21.79	18.73	1433	30.75	25.52

Shaded area diameters are below industry standard for belt.

DRIVE SELECTION TABLES



CENTER DISTANCE AND COMBINED ARC-LENGTH CORRECTION FACTOR ▲

CENTER DISTANCE AND COMBINED ARC-LENGTH CORRECTION FACTOR ▲																LINE #
5VX 530	5VX 560	5VX 630	5VX 710	5VX 750	5VX 800	5VX 900	5VX 1000	5VX 1250	5VX 1400	5VX 1500	5VX 1600	5VX 1800	5VX 1900	5VX 2000	5V 2120	
12.6	14.1	17.6	21.6	23.6	26.1	31.1	36.1	48.6	56.1	61.1	66.1	76.1	81.1	86.1	92.1	51
...	...	14.5	18.5	20.5	23.0	28.0	33.0	45.5	53.0	58.0	63.0	73.0	78.0	83.0	89.0	52
...	16.8	18.8	21.3	26.3	31.3	43.8	51.3	56.3	61.3	71.3	76.3	81.3	87.3	53
...	12.6	16.1	20.1	22.1	24.6	29.6	34.6	47.1	54.6	59.6	64.6	74.6	79.6	84.6	90.6	54
19.2	20.7	24.2	28.2	30.2	32.7	37.7	42.7	55.2	62.7	67.7	72.7	82.7	87.7	92.7	98.7	55
■ 0.84	0.85	0.87	0.89	0.90	0.91	0.94	0.96	1.00	1.02	1.03	1.04	1.07	1.08	1.09	1.10	56
...	...	15.3	19.3	21.3	23.8	28.8	33.8	46.3	53.8	58.8	63.8	73.8	78.8	83.8	89.8	56
18.8	20.3	23.8	27.8	29.8	32.3	37.3	42.3	54.8	62.3	67.3	72.3	82.3	87.3	92.3	98.3	57
...	15.8	17.9	20.4	25.4	30.4	42.9	50.4	55.4	60.4	70.4	75.4	80.4	86.4	58
15.3	16.8	20.3	24.3	26.3	28.8	33.8	38.8	51.3	58.8	63.8	68.8	78.8	83.8	88.8	94.8	59
...	16.7	19.2	24.2	29.2	41.7	49.2	54.2	59.2	69.2	74.2	79.2	85.2	60
■ 0.84	0.85	0.87	0.89	0.90	0.91	0.93	0.95	1.00	1.02	1.03	1.04	1.07	1.08	1.09	1.10	61
18.3	19.8	23.3	27.3	29.3	31.8	36.8	41.8	54.3	61.8	66.8	71.8	81.8	86.8	91.8	97.8	61
13.1	14.6	18.1	22.1	24.1	26.6	31.6	36.6	49.1	56.6	61.6	66.6	76.6	81.6	86.6	92.6	62
14.6	16.1	19.6	23.6	25.6	28.1	33.1	38.1	50.6	58.1	63.1	68.1	78.1	83.1	88.1	94.1	63
16.0	17.5	21.0	25.0	27.0	29.5	34.5	39.5	52.0	59.5	64.5	69.5	79.5	84.5	89.5	95.5	64
13.9	15.4	18.9	22.9	24.9	27.4	32.4	37.4	49.9	57.4	62.4	67.4	77.4	82.4	87.4	93.4	65
■ 0.84	0.85	0.87	0.89	0.90	0.91	0.94	0.96	1.00	1.02	1.03	1.04	1.07	1.08	1.09	1.10	66
...	31.1	38.6	43.6	48.6	58.6	63.7	68.7	74.7	66
17.8	19.3	22.8	26.8	28.8	31.3	36.3	41.3	53.8	61.3	66.3	71.3	81.3	86.3	91.3	97.3	67
16.6	18.1	21.6	25.6	27.6	30.1	35.1	40.1	52.6	60.1	65.1	70.1	80.1	85.1	90.1	96.1	68
...	17.8	22.8	27.8	40.3	47.8	52.8	57.8	67.8	72.8	77.8	83.8	69
...	21.4	26.4	38.9	46.4	51.4	56.4	66.4	71.4	76.4	82.4	70
■ 0.84	0.85	0.87	0.89	0.90	0.91	0.93	0.95	0.99	1.02	1.03	1.04	1.06	1.07	1.08	1.10	71
...	12.8	16.3	20.3	22.3	24.8	29.8	34.8	47.3	54.8	59.8	64.8	74.8	79.8	84.8	90.8	71
17.2	18.7	22.2	26.2	28.2	30.7	35.7	40.7	53.2	60.7	65.7	70.7	80.7	85.7	90.7	96.7	72
...	...	14.1	18.1	20.1	22.6	27.6	32.6	45.1	52.6	57.6	62.6	72.6	77.6	82.6	88.6	73
...	17.1	19.1	21.6	26.6	31.6	44.1	51.6	56.6	61.6	71.6	76.6	81.6	87.6	74
12.2	13.7	17.2	21.2	23.2	25.7	30.7	35.7	48.2	55.7	60.7	65.7	75.7	80.7	85.7	91.7	75
■ 0.83	0.84	0.87	0.89	0.90	0.91	0.93	0.95	1.00	1.02	1.03	1.04	1.07	1.08	1.08	1.10	76
12.9	14.4	17.9	21.9	23.9	26.4	31.4	36.4	48.9	56.4	61.4	66.4	76.4	81.4	86.4	92.4	76
...	...	14.9	19.0	21.0	23.5	28.5	33.5	46.0	53.5	58.5	63.5	73.5	78.5	83.5	89.5	77
...	16.2	18.2	20.7	25.7	30.7	43.2	50.7	55.7	60.8	70.8	75.8	80.8	86.8	78
...	22.7	35.2	42.7	47.7	57.7	62.7	67.7	73.7	79
...	...	15.7	19.7	21.7	24.2	29.2	34.2	46.7	54.2	59.2	64.2	74.2	79.2	84.2	90.2	80
■ 0.83	0.84	0.86	0.89	0.90	0.91	0.93	0.95	0.99	1.02	1.03	1.04	1.06	1.07	1.08	1.09	81
19.0	20.5	24.0	28.0	30.0	32.5	37.5	42.5	55.0	62.5	67.5	72.5	82.5	87.5	92.5	98.5	81
18.5	20.0	23.5	27.5	29.5	32.0	37.0	42.0	54.5	62.0	67.0	72.0	82.0	87.0	92.0	98.0	82
...	17.2	19.7	24.7	29.7	42.2	49.7	54.7	59.7	69.7	74.7	79.7	85.7	83
15.6	17.2	20.7	24.7	26.7	29.2	34.2	39.2	51.7	59.2	64.2	69.2	79.2	84.2	89.2	95.2	84
14.9	16.4	19.9	23.9	25.9	28.4	33.4	38.4	51.0	58.5	63.5	68.5	78.5	83.5	88.5	94.5	85
■ 0.83	0.85	0.87	0.89	0.90	0.91	0.93	0.95	1.00	1.02	1.03	1.04	1.07	1.08	1.08	1.10	86
14.2	15.7	19.2	23.2	25.2	27.7	32.7	37.7	50.2	57.7	62.7	67.7	77.7	82.7	87.7	93.7	86
13.5	15.0	18.5	22.5	24.5	27.0	32.0	37.0	49.5	57.0	62.0	67.0	77.0	82.0	87.0	93.0	87
...	18.4	23.4	28.4	40.9	48.4	53.4	58.4	68.4	73.4	78.4	84.4	88
16.3	17.8	21.3	25.3	27.3	29.8	34.8	39.8	52.3	59.8	64.8	69.8	79.8	84.8	89.8	95.8	89
18.0	19.5	23.0	27.0	29.0	31.5	36.5	41.5	54.0	61.5	66.5	71.5	81.5	86.5	91.5	97.5	90
■ 0.83	0.84	0.87	0.89	0.90	0.91	0.93	0.95	1.00	1.02	1.03	1.04	1.06	1.07	1.08	1.10	91
...	...	14.5	18.5	20.5	23.1	28.1	33.1	45.6	53.1	58.1	63.1	73.1	78.1	83.1	89.1	91
...	16.5	18.5	21.0	26.0	31.0	43.6	51.1	56.1	61.1	71.1	76.1	81.1	87.1	92
...	...	15.8	19.8	21.8	24.4	29.4	34.4	46.9	54.4	59.4	64.4	74.4	79.4	84.4	90.4	93
17.5	19.0	22.5	26.5	28.5	31.0	36.0	41.0	53.5	61.0	66.0	71.0	81.0	86.0	91.0	97.0	94
...	13.2	16.7	20.7	22.7	25.2	30.2	35.2	47.7	55.2	60.2	65.2	75.2	80.2	85.2	91.2	95
■ 0.83	0.84	0.86	0.88	0.90	0.91	0.93	0.95	1.00	1.02	1.03	1.04	1.06	1.07	1.08	1.09	96
...	22.0	27.0	39.5	47.0	52.0	57.0	67.0	72.0	77.0	83.0	96
...	17.6	19.6	22.1	27.1	32.1	44.6	52.1	57.1	62.1	72.1	77.1	82.1	88.1	97
16.9	18.4	21.9	25.9	27.9	30.4	35.4	40.4	52.9	60.4	65.4	70.4	80.4	85.4	90.4	96.4	89
12.5	14.0	17.5	21.5	23.5	26.0	31.0	36.0	48.6	56.1	61.1	66.1	76.1	81.1	86.1	92.1	99
...	...	15.3	19.3	21.3	23.8	28.8	33.8	46.3	53.8	58.8	63.8	73.8	78.8	83.8	89.8	100
■ 0.83	0.84	0.86	0.88	0.90	0.91	0.93	0.95	0.99	1.02	1.03	1.04	1.06	1.07	1.08	1.09	

▲ Not all available belt lengths are shown.

■ Combined Arc-Length correction factors for 5 preceding lines.



5VX & 5V BELTS IN 5V SHEAVES

LINE #	RATIO	STOCK SHEAVES			DRIVEN SPEEDS AND HORSEPOWER RATINGS PER BELT								
		Datum Diameter		Number Grooves	1160 RPM			1750 RPM			3500 RPM		
		DR	DN		Driven Speed	H.P. Ratings		Driven Speed	H.P. Ratings		Driven Speed	H.P. Ratings	
						5VX	5V		5VX	5V		5VX	5V
101	1.23	7.50	9.25	2-10	941	16.56	13.71	1419	23.50	18.85
102	1.24	11.30	14.00	2-10	936	27.74	24.38	1413	38.74	32.59
103	1.25	15.00	18.70	2-10	930	37.83	33.62
104	1.25	4.40	5.50	2-6	928	6.87	4.25	1400	9.67	5.63	2800	16.34	7.49
105	1.26	9.00	11.30	2-10	924	21.10	18.09	1394	29.81	24.69
106	1.26	18.70	23.60	2-10	919	47.02	41.52
107	1.27	7.10	9.00	2-10	915	15.38	12.58	1381	21.85	17.32	2761	36.27	24.40
108	1.27	6.70	8.50	2-6	914	14.15	11.39	1379	20.11	15.68	2759	33.64	22.39
109	1.27	4.65	5.90	2-6	914	7.70	5.08	1379	10.87	6.80	2758	18.44	9.43
110	1.27	6.30	8.00	2-6	914	12.91	10.18	1378	18.35	14.01	2756	30.90	20.20
111	1.27	5.90	7.50	2-6	913	11.66	8.97	1377	16.57	12.31	2753	28.05	17.84
112	1.27	11.80	15.00	2-10	913	29.19	25.75	1377	40.65	34.23
113	1.28	9.25	11.80	2-10	909	21.86	18.83	1372	30.86	25.66
114	1.28	12.50	16.00	2-10	906	31.15	27.57	1367	43.17	36.33
115	1.28	10.30	13.20	2-10	905	24.93	21.75	1366	35.02	29.39
116	1.28	9.75	12.50	2-10	905	23.34	20.24	1365	32.87	27.48
117	1.28	8.50	10.90	2-10	905	19.64	16.70	1365	27.81	22.88
118	1.28	10.90	14.00	2-10	903	26.66	23.39	1363	37.33	31.41
119	1.29	4.90	6.30	2-6	902	8.52	5.89	1361	12.06	7.96	2722	20.50	11.30
120	1.29	8.00	10.30	2-10	901	18.14	15.27	1359	25.73	20.96
121	1.29	5.20	6.70	2-6	900	9.48	6.83	1358	13.44	9.30	2716	22.85	13.39
122	1.29	5.50	7.10	2-6	899	10.43	7.76	1356	14.81	10.62	2711	25.15	15.40
123	1.30	7.50	9.75	2-10	892	16.64	13.82	1346	23.63	19.01
124	1.30	7.10	9.25	2-10	890	15.42	12.64	1343	21.91	17.40	2686	36.39	24.56
125	1.31	9.00	11.80	2-10	885	21.16	18.17	1335	29.91	24.82
126	1.33	16.00	21.20	2-10	875	40.49	36.01
127	1.33	11.30	15.00	2-10	874	27.85	24.51	1318	38.90	32.79
128	1.33	8.50	11.30	2-10	873	19.69	16.77	1316	27.88	22.98
129	1.34	14.00	18.70	2-10	868	35.29	31.38	1310	48.34	40.46
130	1.34	4.40	5.90	2-6	865	6.97	4.38	1305	9.83	5.82	2610	16.64	7.88
131	1.34	6.70	9.00	2-6	864	14.23	11.49	1303	20.23	15.83	2606	33.88	22.70
132	1.35	6.30	8.50	2-6	860	12.99	10.29	1297	18.48	14.17	2594	31.15	20.52
133	1.35	9.25	12.50	2-10	858	21.94	18.93	1295	30.98	25.81
134	1.35	9.75	13.20	2-10	857	23.41	20.33	1293	32.98	27.62
135	1.35	4.65	6.30	2-6	856	7.79	5.19	1292	11.01	6.98	2583	18.71	9.78
136	1.36	5.90	8.00	2-6	856	11.75	9.08	1291	16.70	12.48	2581	28.31	18.18
137	1.36	11.80	16.00	2-10	856	29.28	25.86	1291	40.78	34.40
138	1.36	10.30	14.00	2-10	853	25.01	21.85	1288	35.14	29.54
139	1.36	8.00	10.90	2-10	851	18.22	15.36	1284	25.84	21.10
140	1.36	5.50	7.50	2-6	851	10.50	7.86	1283	14.91	10.76	2567	25.36	15.68
141	1.37	5.20	7.10	2-6	850	9.55	6.93	1282	13.55	9.45	2563	23.08	13.68
142	1.37	4.90	6.70	2-6	848	8.60	5.99	1280	12.18	8.12	2560	20.74	11.61
143	1.37	7.10	9.75	2-10	845	15.49	12.72	1274	22.01	17.53	2549	36.58	24.81
144	1.37	7.50	10.30	2-10	845	16.71	13.91	1274	23.73	19.14
145	1.38	10.90	15.00	2-10	843	26.75	23.50	1272	37.46	31.58
146	1.38	6.70	9.25	2-6	840	14.26	11.53	1268	20.28	15.89	2535	33.97	22.82
147	1.39	8.50	11.80	2-10	836	19.74	16.83	1261	27.95	23.07
148	1.39	9.00	12.50	2-10	835	21.23	18.26	1260	30.01	24.95
149	1.41	8.00	11.30	2-10	821	18.25	15.41	1239	25.89	21.18
150	1.41	15.00	21.20	2-10	821	37.99	33.83

Shaded area diameters are below industry standard for belt.

DRIVE SELECTION TABLES



CENTER DISTANCE AND COMBINED ARC-LENGTH CORRECTION FACTOR ▲																LINE #
5VX 500	5VX 530	5VX 560	5VX 630	5VX 710	5VX 750	5VX 800	5VX 900	5VX 1000	5VX 1250	5VX 1400	5VX 1500	5VX 1600	5VX 1800	5VX 1900	5VX 2000	
11.8	13.3	14.8	18.3	22.3	24.3	26.8	31.8	36.8	49.3	56.8	61.8	66.8	76.8	81.8	86.8	101
...	15.6	17.6	20.1	25.1	30.1	42.6	50.1	55.1	60.1	70.1	75.1	80.1	102
...	23.5	36.0	43.5	48.5	53.5	63.5	68.5	73.5	103
17.2	18.7	20.2	23.7	27.7	29.7	32.2	37.2	42.2	54.7	62.2	67.2	72.2	82.2	87.2	92.2	104
...	15.5	19.5	21.5	24.0	29.0	34.0	46.5	54.0	59.0	64.0	74.0	79.0	84.0	105
■ 0.82	0.83	0.84	0.86	0.88	0.89	0.91	0.93	0.95	0.99	1.01	1.03	1.04	1.06	1.07	1.08	■
...	29.2	36.7	41.7	46.7	56.7	61.7	66.7	106
12.3	13.8	15.3	18.8	22.8	24.8	27.3	32.3	37.3	49.8	57.3	62.3	67.3	77.3	82.3	87.3	107
13.0	14.5	16.0	19.5	23.5	25.5	28.0	33.0	38.1	50.6	58.1	63.1	68.1	78.1	83.1	88.1	108
16.7	18.2	19.7	23.2	27.2	29.2	31.7	36.7	41.7	54.2	61.7	66.7	71.7	81.7	86.7	91.7	109
13.7	15.2	16.7	20.3	24.3	26.3	28.8	33.8	38.8	51.3	58.8	63.8	68.8	78.8	83.8	88.8	110
■ 0.82	0.83	0.84	0.86	0.89	0.90	0.91	0.93	0.95	0.99	1.01	1.03	1.04	1.06	1.07	1.08	■
14.5	16.0	17.5	21.0	25.0	27.0	29.5	34.5	39.5	52.0	59.5	64.5	69.5	79.5	84.5	89.5	111
...	16.4	18.9	23.9	28.9	41.4	48.9	53.9	58.9	68.9	73.9	78.9	112
...	14.9	18.9	20.9	23.4	28.4	33.4	45.9	53.5	58.5	63.5	73.5	78.5	83.5	113
...	17.5	22.5	27.6	40.1	47.6	52.6	57.6	67.6	72.6	77.6	114
...	17.0	19.0	21.5	26.5	31.5	44.0	51.5	56.5	61.5	71.5	76.5	81.5	115
■ 0.82	0.83	0.84	0.86	0.88	0.89	0.90	0.93	0.95	0.99	1.01	1.03	1.04	1.06	1.07	1.08	■
...	14.0	18.0	20.0	22.5	27.5	32.5	45.0	52.5	57.5	62.5	72.5	77.5	82.5	116
...	...	12.7	16.2	20.2	22.2	24.7	29.7	34.7	47.2	54.8	59.8	64.8	74.8	79.8	84.8	117
...	15.9	17.9	20.4	25.4	30.4	42.9	50.4	55.4	60.4	70.4	75.4	80.4	118
16.2	17.7	19.2	22.7	26.7	28.7	31.2	36.2	41.2	53.7	61.2	66.2	71.2	81.2	86.2	91.2	119
...	12.1	13.6	17.1	21.1	23.1	25.6	30.6	35.6	48.1	55.6	60.6	65.6	75.6	80.6	85.6	120
■ 0.82	0.83	0.84	0.86	0.88	0.89	0.91	0.93	0.95	0.99	1.02	1.03	1.04	1.06	1.07	1.08	■
15.6	17.1	18.6	22.1	26.1	28.1	30.6	35.6	40.6	53.1	60.6	65.6	70.6	80.6	85.6	90.6	121
15.1	16.6	18.1	21.6	25.6	27.6	30.1	35.1	40.1	52.6	60.1	65.1	70.1	80.1	85.1	90.1	122
11.4	12.9	14.4	17.9	21.9	23.9	26.4	31.4	36.4	48.9	56.4	61.4	66.4	76.4	81.4	86.4	123
12.1	13.6	15.1	18.6	22.6	24.6	27.1	32.1	37.1	49.6	57.1	62.1	67.1	77.1	82.1	87.1	124
...	15.1	19.1	21.1	23.6	28.6	33.6	46.1	53.6	58.6	63.6	73.6	78.6	83.6	125
■ 0.81	0.83	0.84	0.86	0.88	0.90	0.91	0.93	0.95	0.99	1.02	1.03	1.04	1.06	1.07	1.08	■
...	33.2	40.7	45.7	50.7	60.7	65.7	70.7	126
...	16.7	19.3	24.3	29.3	41.8	49.3	54.3	59.3	69.3	74.3	79.3	127
...	15.9	19.9	21.9	24.4	29.4	34.4	46.9	54.4	59.4	64.4	74.4	79.4	84.4	128
...	19.2	24.2	36.7	44.3	49.3	54.3	64.3	69.3	74.3	129
16.9	18.4	19.9	23.4	27.4	29.4	31.9	36.9	41.9	54.4	61.9	66.9	71.9	81.9	86.9	91.9	130
■ 0.82	0.83	0.84	0.86	0.88	0.89	0.90	0.92	0.94	0.99	1.01	1.02	1.04	1.06	1.07	1.08	■
12.6	14.1	15.6	19.1	23.1	25.1	27.6	32.6	37.6	50.2	57.7	62.7	67.7	77.7	82.7	87.7	131
13.3	14.8	16.3	19.8	23.9	25.9	28.4	33.4	38.4	50.9	58.4	63.4	68.4	78.4	83.4	88.4	132
...	14.3	18.3	20.4	22.9	27.9	32.9	45.4	52.9	57.9	62.9	72.9	77.9	82.9	133
...	17.4	19.4	21.9	26.9	31.9	44.4	51.9	56.9	62.0	72.0	77.0	82.0	134
16.4	17.9	19.4	22.9	26.9	28.9	31.4	36.4	41.4	53.9	61.4	66.4	71.4	81.4	86.4	91.4	135
■ 0.81	0.83	0.84	0.86	0.88	0.89	0.91	0.93	0.95	0.99	1.01	1.03	1.04	1.06	1.07	1.08	■
14.0	15.5	17.1	20.6	24.6	26.6	29.1	34.1	39.1	51.6	59.1	64.1	69.1	79.1	84.1	89.1	136
...	18.0	23.1	28.1	40.6	48.1	53.1	58.1	68.1	73.1	78.1	137
...	16.3	18.3	20.8	25.8	30.9	43.4	50.9	55.9	60.9	70.9	75.9	80.9	138
...	...	13.1	16.6	20.6	22.6	25.1	30.1	35.1	47.6	55.1	60.1	65.1	75.1	80.1	85.1	139
14.8	16.3	17.8	21.3	25.3	27.3	29.8	34.8	39.8	52.3	59.8	64.8	69.8	79.8	84.8	89.8	140
■ 0.81	0.83	0.83	0.86	0.88	0.89	0.90	0.93	0.95	0.99	1.01	1.03	1.04	1.06	1.07	1.08	■
15.3	16.8	18.3	21.8	25.8	27.8	30.3	35.3	40.3	52.8	60.3	65.3	70.3	80.3	85.3	90.3	141
15.9	17.4	18.9	22.4	26.4	28.4	30.9	35.9	40.9	53.4	60.9	65.9	70.9	80.9	85.9	90.9	142
11.7	13.2	14.7	18.2	22.2	24.2	26.7	31.7	36.7	49.2	56.8	61.8	66.8	76.8	81.8	86.8	143
...	12.4	13.9	17.5	21.5	23.5	26.0	31.0	36.0	48.5	56.0	61.0	66.0	76.0	81.0	86.0	144
...	17.0	19.6	24.6	29.6	42.1	49.6	54.6	59.6	69.6	74.6	79.6	145
■ 0.81	0.82	0.84	0.86	0.88	0.89	0.90	0.93	0.95	0.99	1.01	1.03	1.04	1.06	1.07	1.08	■
12.4	13.9	15.4	18.9	22.9	24.9	27.4	32.4	37.5	50.0	57.5	62.5	67.5	77.5	82.5	87.5	146
...	15.5	19.5	21.5	24.0	29.0	41.5	49.0	54.0	59.0	69.0	74.0	79.0	147
...	14.5	18.5	20.5	23.0	28.1	33.1	45.6	53.1	58.1	63.1	73.1	78.1	83.1	148
...	...	12.7	16.3	20.3	22.3	24.8	29.8	34.8	47.3	54.8	59.8	64.8	74.8	79.8	84.8	149
...	21.3	33.9	41.5	46.5	51.5	61.5	66.5	71.5	150
■ 0.81	0.82	0.83	0.85	0.88	0.89	0.90	0.93	0.94	0.99	1.01	1.02	1.04	1.06	1.07	1.08	■

▲ Not all available belt lengths are shown.
 ■ Combined Arc-Length correction factors for 5 preceding lines.



5VX & 5V BELTS IN 5V SHEAVES

LINE #	RATIO	STOCK SHEAVES			DRIVEN SPEEDS AND HORSEPOWER RATINGS PER BELT								
		Datum Diameter		Number Grooves	1160 RPM			1750 RPM			3500 RPM		
		DR	DN		Driven Speed	H.P. Ratings		Driven Speed	H.P. Ratings		Driven Speed	H.P. Ratings	
						5VX	5V		5VX	5V		5VX	5V
151	1.42	11.30	16.00	2-10	819	27.92	24.60	1236	39.00	32.93
152	1.42	13.20	18.70	2-10	819	33.20	29.50	1235	45.77	38.52
153	1.43	9.25	13.20	2-10	813	21.99	19.00	1226	31.06	25.92
154	1.43	6.30	9.00	2-6	812	13.05	10.37	1225	18.57	14.28	2450	31.32	20.75
155	1.43	4.40	6.30	2-6	810	7.04	4.47	1222	9.93	5.96	2444	16.85	8.15
156	1.44	9.75	14.00	2-10	808	23.47	20.41	1219	33.07	27.73
157	1.44	5.90	8.50	2-6	805	11.81	9.16	1215	16.80	12.59	2429	28.49	18.42
158	1.44	4.65	6.70	2-6	805	7.85	5.27	1215	11.10	7.10	2429	18.90	10.02
159	1.44	5.20	7.50	2-6	804	9.60	7.00	1213	13.63	9.55	2427	23.24	13.90
160	1.45	4.90	7.10	2-6	801	8.65	6.06	1208	12.26	8.23	2415	20.91	11.83
161	1.45	7.10	10.30	2-10	800	15.54	12.79	1206	22.09	17.63	2413	36.74	25.02
162	1.45	7.50	10.90	2-10	798	16.76	13.98	1204	23.81	19.25
163	1.45	5.50	8.00	2-6	798	10.56	7.94	1203	15.01	10.88	2406	25.55	15.92
164	1.46	6.70	9.75	2-6	797	14.31	11.60	1203	20.35	15.99	2405	34.12	23.01
165	1.46	10.30	15.00	2-10	797	25.08	21.94	1202	35.24	29.67
166	1.47	9.00	13.20	2-10	791	21.28	18.32	1193	30.08	25.05
167	1.47	10.90	16.00	2-10	790	26.81	23.58	1192	37.55	31.70
168	1.47	6.30	9.25	2-6	790	13.08	10.40	1192	18.60	14.33	2384	31.39	20.84
169	1.47	8.50	12.50	2-10	789	19.79	16.90	1190	28.03	23.18
170	1.48	8.00	11.80	2-10	786	18.29	15.46	1186	25.95	21.25
171	1.48	16.00	23.60	2-10	786	40.60	36.15
172	1.50	12.50	18.70	2-10	775	31.32	27.79	1170	43.42	36.66
173	1.50	18.70	28.00	2-10	775	47.21	41.77
174	1.51	7.50	11.30	2-10	770	16.79	14.01	1162	23.85	19.30
175	1.51	9.25	14.00	2-10	766	22.04	19.06	1156	31.13	26.02
176	1.51	14.00	21.20	2-10	766	35.41	31.53	1156	48.51	40.69
177	1.52	4.40	6.70	2-6	762	7.09	4.53	1149	10.00	6.05	2299	16.99	8.34
178	1.53	5.90	9.00	2-6	760	11.86	9.21	1147	16.86	12.68	2294	28.62	18.59
179	1.53	4.65	7.10	2-6	760	7.89	5.33	1146	11.17	7.18	2292	19.03	10.19
180	1.53	4.90	7.50	2-6	758	8.69	6.12	1143	12.32	8.31	2287	21.03	11.99
181	1.54	7.10	10.90	2-10	756	15.58	12.84	1140	22.15	17.71	2280	36.87	25.18
182	1.54	6.70	10.30	2-6	755	14.35	11.65	1138	20.41	16.07	2277	34.24	23.17
183	1.54	5.20	8.00	2-6	754	9.65	7.06	1138	13.70	9.64	2275	23.38	14.08
184	1.54	9.75	15.00	2-10	754	23.52	20.48	1138	33.15	27.84
185	1.55	5.50	8.50	2-6	751	10.61	7.99	1132	15.07	10.97	2265	25.68	16.09
186	1.55	6.30	9.75	2-6	750	13.11	10.45	1131	18.66	14.40	2262	31.51	20.99
187	1.55	8.50	13.20	2-10	747	19.83	16.95	1127	28.09	23.25
188	1.55	10.30	16.00	2-10	747	25.12	22.00	1127	35.31	29.76
189	1.56	9.00	14.00	2-10	746	21.32	18.38	1125	30.14	25.13
190	1.56	8.00	12.50	2-10	742	18.33	15.51	1120	26.01	21.33
191	1.57	5.90	9.25	2-6	740	11.87	9.24	1116	16.89	12.71	2232	28.67	18.65
192	1.57	7.50	11.80	2-10	737	16.82	14.05	1112	23.89	19.36
193	1.57	15.00	23.60	2-10	737	38.07	33.93
194	1.58	11.80	18.70	2-10	732	29.41	26.03	1104	40.97	34.65
195	1.59	7.10	11.30	2-10	729	15.60	12.87	1100	22.18	17.75	2199	36.93	25.26
196	1.61	13.20	21.20	2-10	722	33.28	29.61	1090	45.91	38.70
197	1.61	4.65	7.50	2-6	719	7.92	5.37	1085	11.21	7.25	2170	19.13	10.32
198	1.61	4.40	7.10	2-6	719	7.12	4.58	1085	10.05	6.12	2169	17.10	8.47
199	1.62	9.25	15.00	2-10	715	22.08	19.12	1079	31.19	26.10
200	1.63	6.70	10.90	2-6	713	14.38	11.69	1076	20.46	16.13	2151	34.34	23.29

Shaded area diameters are below industry standard for belt.

DRIVE SELECTION TABLES



CENTER DISTANCE AND COMBINED ARC-LENGTH CORRECTION FACTOR ▲																LINE #
5VX 500	5VX 530	5VX 560	5VX 630	5VX 710	5VX 750	5VX 800	5VX 900	5VX 1000	5VX 1250	5VX 1400	5VX 1500	5VX 1600	5VX 1800	5VX 1900	5VX 2000	
...	18.4	23.4	28.5	41.0	48.5	53.5	58.5	68.5	73.5	78.5	151
...	19.8	24.8	37.3	44.9	49.9	54.9	64.9	69.9	74.9	152
...	13.7	17.8	19.8	22.3	27.3	32.3	44.8	52.3	57.3	62.3	72.3	77.3	82.3	153
12.9	14.4	15.9	19.4	23.4	25.4	28.0	33.0	38.0	50.5	58.0	63.0	68.0	78.0	83.0	88.0	154
16.6	18.1	19.6	23.1	27.1	29.1	31.6	36.6	41.6	54.1	61.6	66.6	71.6	81.6	86.6	91.6	155
■ 0.81	■ 0.83	■ 0.84	■ 0.85	■ 0.88	■ 0.89	■ 0.90	■ 0.92	■ 0.94	■ 0.99	■ 1.01	■ 1.02	■ 1.04	■ 1.06	■ 1.07	■ 1.08	
...	16.7	18.7	21.2	26.3	31.3	43.8	51.3	56.3	61.3	71.3	76.3	81.3	156
13.6	15.1	16.6	20.1	24.2	26.2	28.7	33.7	38.7	51.2	58.7	63.7	68.7	78.7	83.7	88.7	157
16.1	17.6	19.1	22.6	26.6	28.6	31.1	36.1	41.1	53.6	61.1	66.1	71.1	81.1	86.1	91.1	158
15.0	16.5	18.0	21.5	25.5	27.5	30.0	35.0	40.0	52.5	60.0	65.0	70.0	80.0	85.0	90.0	159
15.5	17.0	18.5	22.0	26.1	28.1	30.6	35.6	40.6	53.1	60.6	65.6	70.6	80.6	85.6	90.6	160
■ 0.81	■ 0.83	■ 0.84	■ 0.86	■ 0.88	■ 0.89	■ 0.91	■ 0.93	■ 0.95	■ 0.99	■ 1.01	■ 1.03	■ 1.04	■ 1.06	■ 1.07	■ 1.08	
11.2	12.7	14.2	17.8	21.8	23.8	26.3	31.3	36.3	48.8	56.3	61.3	66.3	76.3	81.3	86.3	161
...	11.9	13.4	17.0	21.0	23.0	25.5	30.5	35.5	48.0	55.5	60.5	65.5	75.5	80.5	85.5	162
14.3	15.8	17.4	20.9	24.9	26.9	29.4	34.4	39.4	51.9	59.4	64.4	69.4	79.4	84.4	89.4	163
12.0	13.5	15.0	18.5	22.5	24.5	27.0	32.0	37.0	49.6	57.1	62.1	67.1	77.1	82.1	87.1	164
...	15.5	17.5	20.0	25.0	30.0	42.6	50.1	55.1	60.1	70.1	75.1	80.1	165
■ 0.80	■ 0.82	■ 0.83	■ 0.85	■ 0.87	■ 0.89	■ 0.90	■ 0.93	■ 0.95	■ 0.99	■ 1.01	■ 1.03	■ 1.04	■ 1.06	■ 1.07	■ 1.08	
...	13.9	17.9	20.0	22.5	27.5	32.5	45.0	52.5	57.5	62.5	72.5	77.5	82.5	166
...	16.2	18.7	23.7	28.8	41.3	48.8	53.8	58.8	68.8	73.8	78.8	167
12.7	14.2	15.7	19.2	23.2	25.2	27.7	32.8	37.8	50.3	57.8	62.8	67.8	77.8	82.8	87.8	168
...	14.9	18.9	20.9	23.4	28.4	33.4	46.0	53.5	58.5	63.5	73.5	78.5	83.5	169
...	15.8	19.9	21.9	24.4	29.4	34.4	46.9	54.4	59.4	64.4	74.4	79.4	84.4	170
■ 0.80	■ 0.82	■ 0.83	■ 0.84	■ 0.87	■ 0.88	■ 0.90	■ 0.92	■ 0.94	■ 0.99	■ 1.01	■ 1.02	■ 1.04	■ 1.06	■ 1.07	■ 1.08	
...	31.2	38.7	43.7	48.8	58.8	63.8	68.8	171
...	20.3	25.3	37.9	45.4	50.4	55.4	65.4	70.4	75.4	172
...	33.0	38.0	43.1	53.1	58.1	63.2	173
...	...	13.1	16.6	20.6	22.7	25.2	30.2	35.2	47.7	55.2	60.2	65.2	75.2	80.2	85.2	174
...	17.1	19.1	21.6	26.6	31.7	44.2	51.7	56.7	61.7	71.7	76.7	81.7	175
■		■ 0.82	■ 0.85	■ 0.87	■ 0.88	■ 0.89	■ 0.91	■ 0.94	■ 0.98	■ 1.00	■ 1.01	■ 1.03	■ 1.05	■ 1.06	■ 1.07	
...	22.1	34.7	42.2	47.2	52.2	62.2	67.2	72.2	176
16.2	17.7	19.2	22.8	26.8	28.8	31.3	36.3	41.3	53.8	61.3	66.3	71.3	81.3	86.3	91.3	177
13.2	14.7	16.2	19.7	23.7	25.8	28.3	33.3	38.3	50.8	58.3	63.3	68.3	78.3	83.3	88.3	178
15.7	17.2	18.7	22.2	26.2	28.2	30.7	35.8	40.8	53.3	60.8	65.8	70.8	80.8	85.8	90.8	179
15.2	16.7	18.2	21.7	25.7	27.7	30.2	35.2	40.2	52.7	60.2	65.2	70.2	80.2	85.2	90.2	180
■ 0.81	■ 0.82	■ 0.84	■ 0.86	■ 0.88	■ 0.89	■ 0.91	■ 0.93	■ 0.94	■ 0.99	■ 1.01	■ 1.03	■ 1.04	■ 1.06	■ 1.07	■ 1.08	
...	12.2	13.7	17.3	21.3	23.3	25.8	30.8	35.8	48.3	55.8	60.8	65.8	75.8	80.8	85.8	181
11.5	13.0	14.5	18.1	22.1	24.1	26.6	31.6	36.6	49.1	56.6	61.6	66.6	76.6	81.6	86.6	182
14.6	16.1	17.6	21.1	25.1	27.1	29.6	34.6	39.6	52.1	59.6	64.6	69.6	79.6	84.6	89.6	183
...	15.8	17.9	20.4	25.4	30.4	43.0	50.5	55.5	60.5	70.5	75.5	80.5	184
13.9	15.4	16.9	20.4	24.5	26.5	29.0	34.0	39.0	51.5	59.0	64.0	69.0	79.0	84.0	89.0	185
■ 0.80	■ 0.81	■ 0.83	■ 0.85	■ 0.87	■ 0.89	■ 0.90	■ 0.92	■ 0.95	■ 0.99	■ 1.01	■ 1.03	■ 1.04	■ 1.06	■ 1.07	■ 1.08	
12.3	13.8	15.3	18.8	22.8	24.8	27.3	32.3	37.4	49.9	57.4	62.4	67.4	77.4	82.4	87.4	186
...	14.3	18.3	20.3	22.8	27.9	32.9	45.4	52.9	57.9	62.9	72.9	77.9	82.9	187
...	16.6	19.1	24.2	29.2	41.7	49.3	54.3	59.3	69.3	74.3	79.3	188
...	17.3	19.3	21.8	26.8	31.8	44.4	51.9	56.9	61.9	71.9	76.9	81.9	189
...	15.2	19.3	21.3	23.8	28.8	33.8	46.3	53.9	58.9	63.9	73.9	78.9	83.9	190
■ 0.80	■ 0.81	■ 0.83	■ 0.84	■ 0.87	■ 0.88	■ 0.89	■ 0.92	■ 0.94	■ 0.99	■ 1.01	■ 1.02	■ 1.04	■ 1.06	■ 1.07	■ 1.08	
13.0	14.5	16.0	19.5	23.5	25.5	28.1	33.1	38.1	50.6	58.1	63.1	68.1	78.1	83.1	88.1	191
...	...	12.7	16.2	20.2	22.2	24.7	29.8	34.8	47.3	54.8	59.8	64.8	74.8	79.8	84.8	192
...	31.9	39.4	44.5	49.5	59.5	64.5	69.5	193
...	20.8	25.8	38.4	45.9	50.9	55.9	66.0	71.0	76.0	194
...	11.9	13.4	16.9	20.9	23.0	25.5	30.5	35.5	48.0	55.5	60.5	65.5	75.5	80.5	85.5	195
■ 0.80	■ 0.81	■ 0.82	■ 0.85	■ 0.87	■ 0.89	■ 0.90	■ 0.92	■ 0.94	■ 0.98	■ 1.01	■ 1.02	■ 1.03	■ 1.06	■ 1.07	■ 1.08	
...	22.6	35.3	42.8	47.8	52.8	62.9	67.9	72.9	196
15.4	16.9	18.4	21.9	25.9	27.9	30.4	35.4	40.4	52.9	60.4	65.4	70.4	80.4	85.4	90.4	197
15.9	17.4	18.9	22.4	26.4	28.4	30.9	35.9	40.9	53.5	61.0	66.0	71.0	81.0	86.0	91.0	198
...	16.2	18.2	20.8	25.8	30.8	43.4	50.9	55.9	60.9	70.9	75.9	80.9	199
...	12.5	14.0	17.6	21.6	23.6	26.1	31.1	36.1	48.6	56.1	61.1	66.1	76.1	81.1	86.2	200
■ 0.81	■ 0.82	■ 0.83	■ 0.85	■ 0.87	■ 0.88	■ 0.90	■ 0.92	■ 0.94	■ 0.99	■ 1.01	■ 1.02	■ 1.04	■ 1.06	■ 1.07	■ 1.08	

▲ Not all available belt lengths are shown.

■ Combined Arc-Length correction factors for 5 preceding lines.



5VX & 5V BELTS IN 5V SHEAVES

LINE #	RATIO	STOCK SHEAVES			DRIVEN SPEEDS AND HORSEPOWER RATINGS PER BELT								
		Datum Diameter		Number Grooves	1160 RPM			1750 RPM			3500 RPM		
		DR	DN		Driven Speed	H.P. Ratings		Driven Speed	H.P. Ratings		Driven Speed	H.P. Ratings	
						5VX	5V		5VX	5V		5VX	5V
201	1.63	4.90	8.00	2-6	711	8.73	6.17	1072	12.38	8.38	2144	21.14	12.14
202	1.63	5.20	8.50	2-6	710	9.69	7.10	1071	13.75	9.71	2141	23.49	14.22
203	1.63	6.30	10.30	2-6	710	13.14	10.49	1070	18.70	14.46	2141	31.60	21.11
204	1.64	5.50	9.00	2-6	709	10.64	8.04	1069	15.12	11.03	2139	25.78	16.22
205	1.64	9.75	16.00	2-10	707	23.55	20.52	1066	33.20	27.91
206	1.65	8.50	14.00	2-10	704	19.86	16.99	1063	28.14	23.31
207	1.65	8.00	13.20	2-10	703	18.36	15.55	1061	26.05	21.38
208	1.65	5.90	9.75	2-6	702	11.90	9.27	1059	16.93	12.77	2118	28.76	18.76
209	1.65	11.30	18.70	2-10	701	28.02	24.74	1057	39.16	33.13
210	1.66	7.10	11.80	2-10	698	15.62	12.90	1053	22.22	17.80	2106	37.00	25.35
211	1.67	7.50	12.50	2-10	696	16.85	14.09	1050	23.94	19.42
212	1.67	9.00	15.00	2-10	696	21.35	18.43	1050	30.20	25.20
213	1.68	5.50	9.25	2-6	690	10.65	8.05	1041	15.14	11.05	2081	25.82	16.27
214	1.68	18.70	31.50	3-10	689	47.28	41.85
215	1.69	14.00	23.60	2-10	688	35.46	31.61	1038	48.60	40.80
216	1.69	6.70	11.30	2-6	688	14.40	11.71	1038	20.49	16.16	2075	34.39	23.36
217	1.70	12.50	21.20	2-10	684	31.39	27.88	1032	43.53	36.80
218	1.70	4.40	7.50	2-6	681	7.15	4.61	1027	10.09	6.17	2053	17.17	8.57
219	1.72	10.90	18.70	2-10	676	26.90	23.69	1020	37.68	31.87
220	1.72	4.65	8.00	2-6	674	7.95	5.41	1017	11.26	7.31	2034	19.22	10.43
221	1.73	9.25	16.00	2-10	671	22.11	19.15	1012	31.24	26.15
222	1.73	6.30	10.90	2-6	670	13.17	10.52	1011	18.74	14.51	2023	31.67	21.21
223	1.73	5.20	9.00	2-6	670	9.71	7.14	1011	13.79	9.76	2022	23.56	14.32
224	1.73	4.90	8.50	2-6	669	8.76	6.20	1009	12.42	8.43	2018	21.22	12.24
225	1.75	5.90	10.30	2-6	664	11.92	9.30	1002	16.96	12.81	2005	28.83	18.85
226	1.75	8.00	14.00	2-10	663	18.38	15.58	1000	26.09	21.43
227	1.75	16.00	28.00	2-10	663	40.69	36.27
228	1.76	7.50	13.20	2-10	659	16.87	14.12	994	23.97	19.46
229	1.76	7.10	12.50	2-10	659	15.65	12.93	994	22.25	17.84	1988	37.07	25.44
230	1.76	6.70	11.80	2-6	659	14.42	11.73	994	20.51	16.20	1987	34.44	23.43
231	1.76	8.50	15.00	2-10	657	19.89	17.03	992	28.18	23.37
232	1.77	5.50	9.75	2-6	654	10.67	8.08	987	15.17	11.09	1974	25.88	16.35
233	1.78	9.00	16.00	2-10	653	21.38	18.46	984	30.24	25.25
234	1.78	5.20	9.25	2-6	652	9.72	7.15	984	13.81	9.78	1968	23.59	14.36
235	1.79	13.20	23.60	2-10	649	33.33	29.67	979	45.98	38.78
236	1.79	6.30	11.30	2-6	647	13.18	10.53	976	18.76	14.53	1951	31.71	21.26
237	1.80	11.80	21.20	2-10	646	29.46	26.10	974	41.05	34.76
238	1.82	10.30	18.70	2-10	639	25.19	22.09	964	35.42	29.90
239	1.82	4.40	8.00	2-6	638	7.17	4.64	963	10.13	6.21	1925	17.24	8.66
240	1.83	4.65	8.50	2-6	635	7.97	5.44	957	11.29	7.35	1915	19.28	10.52
241	1.84	4.90	9.00	2-6	632	8.78	6.22	953	12.45	8.47	1906	21.28	12.32
242	1.85	5.90	10.90	2-6	628	11.94	9.33	947	16.99	12.85	1894	28.88	18.93
243	1.86	7.10	13.20	2-10	624	15.66	12.95	941	22.28	17.88	1883	37.12	25.51
244	1.87	6.70	12.50	2-6	622	14.43	11.76	938	20.54	16.23	1876	34.50	23.50
245	1.87	7.50	14.00	2-10	621	16.89	14.14	938	24.00	19.50
246	1.87	15.00	28.00	2-10	621	38.14	34.02
247	1.87	5.50	10.30	2-6	619	10.69	8.10	934	15.20	11.13	1869	25.93	16.41
248	1.87	6.30	11.80	2-6	619	13.20	10.55	934	18.78	14.56	1869	31.75	21.31
249	1.88	8.00	15.00	2-10	619	18.41	15.61	933	26.12	21.48
250	1.88	5.20	9.75	2-6	619	9.74	7.17	933	13.83	9.81	1867	23.64	14.42

Shaded area diameters are below industry standard for belt.

DRIVE SELECTION TABLES



CENTER DISTANCE AND COMBINED ARC-LENGTH CORRECTION FACTOR ▲																LINE #
5VX 500	5VX 530	5VX 560	5VX 630	5VX 710	5VX 750	5VX 800	5VX 900	5VX 1000	5VX 1250	5VX 1400	5VX 1500	5VX 1600	5VX 1800	5VX 1900	5VX 2000	
14.8	16.3	17.8	21.3	25.3	27.3	29.8	34.8	39.8	52.3	59.8	64.8	69.9	79.9	84.9	89.9	201
14.1	15.7	17.2	20.7	24.7	26.7	29.2	34.2	39.2	51.7	59.2	64.2	69.2	79.2	84.2	89.2	202
11.8	13.3	14.8	18.4	22.4	24.4	26.9	31.9	36.9	49.4	56.9	61.9	66.9	76.9	81.9	86.9	203
13.5	15.0	16.5	20.0	24.0	26.1	28.6	33.6	38.6	51.1	58.6	63.6	68.6	78.6	83.6	88.6	204
...	17.0	19.5	24.6	29.6	42.2	49.7	54.7	59.7	69.7	74.7	79.7	205
■ 0.80	0.81	0.83	0.85	0.88	0.88	0.90	0.92	0.94	0.99	1.01	1.02	1.04	1.06	1.07	1.08	
...	17.6	19.6	22.2	27.2	32.2	44.7	52.3	57.3	62.3	72.3	77.3	82.3	206
...	14.6	18.7	20.7	23.2	28.2	33.2	45.8	53.3	58.3	63.3	73.3	78.3	83.3	207
12.6	14.1	15.6	19.1	23.1	25.1	27.6	32.7	37.7	50.2	57.7	62.7	67.7	77.7	82.7	87.7	208
...	21.1	26.2	38.8	46.3	51.3	56.3	66.3	71.3	76.3	209
...	...	12.9	16.5	20.5	22.5	25.0	30.1	35.1	47.6	55.1	60.1	65.1	75.1	80.1	85.1	210
■ 0.80	0.81	0.82	0.84	0.87	0.88	0.89	0.91	0.94	0.98	1.01	1.02	1.03	1.06	1.07	1.08	
...	15.6	19.6	21.6	24.2	29.2	34.2	46.7	54.2	59.2	64.2	74.2	79.3	84.3	211
...	16.4	18.4	20.9	26.0	31.0	43.5	51.1	56.1	61.1	71.1	76.1	81.1	212
13.3	14.8	16.3	19.8	23.8	25.8	28.4	33.4	38.4	50.9	58.4	63.4	68.4	78.4	83.4	88.4	213
...	29.9	35.0	40.1	50.1	55.2	60.2	65.2	214
...	32.6	40.2	45.2	50.2	60.3	65.3	70.3	215
■ 0.80	0.81	0.82	0.84	0.86	0.88	0.89	0.92	0.94	0.98	0.99	1.01	1.02	1.05	1.06	1.07	
...	12.1	13.7	17.2	21.2	23.2	25.8	30.8	35.8	48.3	55.8	60.8	65.8	75.8	80.8	85.8	216
...	23.1	35.8	43.3	48.3	53.4	63.4	68.4	73.4	217
15.6	17.1	18.6	22.1	26.1	28.1	30.6	35.6	40.6	53.1	60.6	65.6	70.6	80.6	85.6	90.6	218
...	21.4	26.5	39.1	46.6	51.6	56.6	66.6	71.6	76.7	219
15.0	16.5	18.0	21.5	25.5	27.5	30.0	35.0	40.0	52.5	60.0	65.0	70.0	80.0	85.0	90.0	220
■ 0.81	0.81	0.82	0.85	0.88	0.89	0.90	0.92	0.93	0.98	1.01	1.02	1.03	1.06	1.07	1.08	
...	15.3	17.3	19.9	24.9	30.0	42.5	50.1	55.1	60.1	70.1	75.1	80.1	221
11.3	12.8	14.3	17.8	21.9	23.9	26.4	31.4	36.4	48.9	56.4	61.4	66.5	76.5	81.5	86.5	222
13.7	15.2	16.7	20.3	24.3	26.3	28.8	33.8	38.8	51.3	58.8	63.8	68.8	78.8	83.8	88.8	223
14.4	15.9	17.4	20.9	24.9	26.9	29.4	34.4	39.4	51.9	59.4	64.5	69.5	79.5	84.5	89.5	224
12.1	13.6	15.1	18.6	22.7	24.7	27.2	32.2	37.2	49.7	57.2	62.2	67.2	77.2	82.2	87.2	225
■ 0.79	0.81	0.82	0.85	0.87	0.88	0.89	0.92	0.94	0.99	1.01	1.02	1.04	1.06	1.07	1.08	
...	13.9	18.0	20.0	22.5	27.6	32.6	45.1	52.6	57.6	62.6	72.7	77.7	82.7	226
...	27.3	34.9	40.0	45.0	55.1	60.1	65.2	227
...	15.0	19.0	21.0	23.6	28.6	33.6	46.2	53.7	58.7	63.7	73.7	78.7	83.7	228
...	...	12.3	15.9	19.9	21.9	24.5	29.5	34.5	47.0	54.5	59.5	64.5	74.6	79.6	84.6	229
...	...	13.2	16.8	20.8	22.8	25.3	30.4	35.4	47.9	55.4	60.4	65.4	75.4	80.4	85.4	230
■		0.80	0.83	0.86	0.87	0.89	0.92	0.94	0.97	1.00	1.02	1.03	1.05	1.06	1.07	
...	16.7	18.8	21.3	26.3	31.4	43.9	51.4	56.4	61.5	71.5	76.5	81.5	231
12.8	14.4	15.9	19.4	23.4	25.4	27.9	33.0	38.0	50.5	58.0	63.0	68.0	78.0	83.0	88.0	232
...	15.5	17.5	20.1	25.1	30.2	42.7	50.2	55.3	60.3	70.3	75.3	80.3	233
13.5	15.0	16.5	20.0	24.1	26.1	28.6	33.6	38.6	51.1	58.6	63.6	68.6	78.6	83.6	88.6	234
...	33.2	40.8	45.8	50.8	60.9	65.9	70.9	235
■ 0.79	0.81	0.82	0.85	0.86	0.87	0.89	0.91	0.94	0.98	1.00	1.02	1.03	1.05	1.07	1.08	
...	12.4	14.0	17.5	21.5	23.5	26.1	31.1	36.1	48.6	56.1	61.1	66.1	76.1	81.1	86.1	236
...	23.6	36.3	43.8	48.9	53.9	63.9	68.9	73.9	237
...	21.8	26.9	39.5	47.0	52.1	57.1	67.1	72.1	77.1	238
15.2	16.7	18.2	21.7	25.7	27.7	30.2	35.2	40.2	52.7	60.2	65.2	70.2	80.2	85.2	90.2	239
14.5	16.1	17.6	21.1	25.1	27.1	29.6	34.6	39.6	52.1	59.6	64.6	69.6	79.6	84.7	89.7	240
■ 0.80	0.81	0.82	0.85	0.87	0.89	0.90	0.91	0.93	0.98	1.00	1.02	1.03	1.06	1.07	1.08	
13.9	15.4	17.0	20.5	24.5	26.5	29.0	34.0	39.0	51.5	59.0	64.1	69.1	79.1	84.1	89.1	241
11.5	13.1	14.6	18.1	22.2	24.2	26.7	31.7	36.7	49.2	56.8	61.8	66.8	76.8	81.8	86.8	242
...	15.3	19.3	21.3	23.9	28.9	33.9	46.5	54.0	59.0	64.0	74.0	79.0	84.0	243
...	...	12.6	16.2	20.2	22.2	24.8	29.8	34.8	47.3	54.8	59.9	64.9	74.9	79.9	84.9	244
...	14.2	18.3	20.4	22.9	27.9	33.0	45.5	53.0	58.0	63.0	73.0	78.0	83.1	245
■ 0.79	0.80	0.81	0.83	0.86	0.88	0.89	0.92	0.94	0.98	1.01	1.02	1.03	1.06	1.07	1.08	
...	28.0	35.6	40.7	45.8	55.8	60.9	65.9	246
12.4	13.9	15.4	18.9	23.0	25.0	27.5	32.5	37.5	50.0	57.5	62.5	67.5	77.6	82.6	87.6	247
...	12.0	13.5	17.1	21.1	23.1	25.6	30.7	35.7	48.2	55.7	60.7	65.7	75.7	80.7	85.7	248
...	17.1	19.1	21.7	26.7	31.7	44.3	51.8	56.8	61.8	71.9	76.9	81.9	249
13.1	14.6	16.1	19.6	23.6	25.7	28.2	33.2	38.2	50.7	58.2	63.2	68.2	78.2	83.2	88.2	250
■ 0.79	0.80	0.81	0.84	0.86	0.88	0.89	0.92	0.94	0.97	1.00	1.01	1.03	1.05	1.06	1.07	

▲ Not all available belt lengths are shown.

■ Combined Arc-Length correction factors for 5 preceding lines.



5VX & 5V BELTS IN 5V SHEAVES

LINE #	RATIO	STOCK SHEAVES			DRIVEN SPEEDS AND HORSEPOWER RATINGS PER BELT								
		Datum Diameter		Number Grooves	1160 RPM			1750 RPM			3500 RPM		
		DR	DN		Driven Speed	H.P. Ratings		Driven Speed	H.P. Ratings		Driven Speed	H.P. Ratings	
						5VX	5V		5VX	5V		5VX	5V
251	1.88	11.30	21.20	2-10	618	28.07	24.80	933	39.23	33.22
252	1.88	8.50	16.00	2-10	616	19.91	17.05	930	28.21	23.41
253	1.89	4.90	9.25	2-6	614	8.78	6.23	927	12.46	8.49	1854	21.30	12.35
254	1.89	12.50	23.60	2-10	614	31.43	27.93	927	43.58	36.87
255	1.92	5.90	11.30	2-6	606	11.95	9.34	914	17.01	12.87	1827	28.91	18.97
256	1.92	9.75	18.70	2-10	605	23.61	20.59	912	33.28	28.02
257	1.93	4.40	8.50	2-6	600	7.19	4.66	906	10.15	6.25	1812	17.29	8.73
258	1.94	4.65	9.00	2-6	599	7.99	5.46	904	11.31	7.38	1808	19.33	10.58
259	1.94	10.90	21.20	2-10	596	26.94	23.74	900	37.74	31.95
260	1.97	16.00	31.50	3-10	589	40.73	36.31
261	1.97	6.70	13.20	2-6	589	14.45	11.78	888	20.56	16.26	1777	34.54	23.55
262	1.97	7.10	14.00	2-10	588	15.68	12.97	888	22.30	17.91	1775	37.17	25.57
263	1.98	5.20	10.30	2-6	586	9.75	7.19	883	13.85	9.84	1767	23.68	14.47
264	1.98	5.50	10.90	2-6	585	10.70	8.12	883	15.22	11.15	1766	25.97	16.47
265	1.98	6.30	12.50	2-6	585	13.21	10.57	882	18.80	14.59	1764	31.80	21.36
266	1.99	4.65	9.25	2-6	583	8.00	5.47	880	11.32	7.39	1759	19.35	10.60
267	1.99	4.90	9.75	2-6	583	8.80	6.25	879	12.48	8.51	1759	21.34	12.40
268	2.00	5.90	11.80	2-6	580	11.96	9.35	875	17.02	12.89	1750	28.94	19.01
269	2.00	7.50	15.00	2-10	580	16.91	14.16	875	24.03	19.53
270	2.00	8.00	16.00	2-10	580	18.42	15.63	875	26.15	21.51
271	2.00	11.80	23.60	2-10	580	29.49	26.14	875	41.09	34.82
272	2.00	14.00	28.00	2-10	580	35.52	31.68	875	48.68	40.91
273	2.01	18.70	37.50	3-10	578	47.33	41.92
274	2.02	9.25	18.70	2-10	574	22.15	19.21	866	31.30	26.24
275	2.05	4.40	9.00	2-6	567	7.20	4.68	856	10.17	6.27	1711	17.33	8.78
276	2.05	5.50	11.30	2-6	565	10.71	8.13	852	15.23	11.17	1704	26.00	16.50
277	2.06	10.30	21.20	2-10	564	25.22	22.13	850	35.46	29.96
278	2.08	9.00	18.70	2-10	558	21.42	18.51	842	30.30	25.33
279	2.09	11.30	23.60	2-10	555	28.09	24.83	838	39.27	33.27
280	2.09	6.70	14.00	2-6	555	14.46	11.79	837	20.58	16.28	1675	34.57	23.60
281	2.10	6.30	13.20	2-6	554	13.22	10.58	835	18.82	14.61	1670	31.83	21.41
282	2.10	5.20	10.90	2-6	553	9.76	7.20	835	13.87	9.86	1670	23.72	14.52
283	2.10	4.65	9.75	2-6	553	8.01	5.48	835	11.34	7.41	1669	19.38	10.64
284	2.10	15.00	31.50	3-10	552	38.17	34.06
285	2.10	4.90	10.30	2-6	552	8.81	6.27	833	12.50	8.53	1665	21.37	12.44
286	2.10	4.40	9.25	2-6	552	7.20	4.69	832	10.18	6.28	1665	17.35	8.80
287	2.11	7.10	15.00	2-10	549	15.69	12.99	828	22.32	17.93	1657	37.21	25.62
288	2.12	5.90	12.50	2-6	548	11.97	9.37	826	17.04	12.91	1652	28.98	19.05
289	2.12	13.20	28.00	2-10	547	33.37	29.73	825	46.04	38.87
290	2.13	7.50	16.00	2-10	544	16.92	14.18	820	24.05	19.55
291	2.15	5.50	11.80	2-6	541	10.72	8.14	816	15.24	11.18	1631	26.02	16.53
292	2.17	10.90	23.60	2-10	536	26.96	23.77	808	37.78	31.99
293	2.17	5.20	11.30	2-6	534	9.77	7.21	805	13.88	9.87	1611	23.74	14.54
294	2.17	9.75	21.20	2-10	533	23.64	20.63	805	33.32	28.07
295	2.20	8.50	18.70	2-10	527	19.94	17.10	795	28.26	23.47
296	2.22	4.65	10.30	2-6	524	8.02	5.49	790	11.35	7.43	1580	19.40	10.68
297	2.22	4.40	9.75	2-6	523	7.21	4.70	790	10.19	6.30	1579	17.37	8.83
298	2.22	6.30	14.00	2-6	522	13.23	10.60	788	18.83	14.63	1575	31.86	21.44
299	2.22	4.90	10.90	2-6	521	8.82	6.28	787	12.51	8.55	1573	21.40	12.48
300	2.24	5.90	13.20	2-6	518	11.98	9.38	782	17.05	12.93	1564	29.00	19.08

Shaded area diameters are below industry standard for belt.

DRIVE SELECTION TABLES



CENTER DISTANCE AND COMBINED ARC-LENGTH CORRECTION FACTOR ▲

CENTER DISTANCE AND COMBINED ARC-LENGTH CORRECTION FACTOR ▲																LINE #
5VX 530	5VX 560	5VX 630	5VX 710	5VX 750	5VX 800	5VX 900	5VX 1000	5VX 1250	5VX 1400	5VX 1500	5VX 1600	5VX 1800	5VX 1900	5VX 2000	5V 2120	
...	18.8	24.0	36.6	44.2	49.2	54.2	64.3	69.3	74.3	80.3	251
...	15.8	17.9	20.4	25.5	30.5	43.1	50.6	55.6	60.6	70.7	75.7	80.7	86.7	252
15.2	16.7	20.3	24.3	26.3	28.8	33.8	38.8	51.3	58.8	63.8	68.9	78.9	83.9	88.9	94.9	253
...	20.9	33.7	41.3	46.3	51.3	61.4	66.4	71.4	77.4	254
12.7	14.2	17.8	21.8	23.8	26.4	31.4	36.4	48.9	56.4	61.4	66.4	76.4	81.4	86.4	92.5	255
■ 0.80	0.81	0.84	0.86	0.87	0.89	0.90	0.92	0.97	1.00	1.01	1.03	1.05	1.06	1.07	1.08	256
...	17.1	22.2	27.3	39.9	47.4	52.5	57.5	67.5	72.5	77.5	83.5	256
16.2	17.7	21.3	25.3	27.3	29.8	34.8	39.8	52.3	59.8	64.8	69.8	79.8	84.8	89.8	95.8	257
15.6	17.1	20.7	24.7	26.7	29.2	34.2	39.2	51.7	59.2	64.2	69.2	79.2	84.3	89.3	95.3	258
...	19.1	24.2	36.9	44.5	49.5	54.5	64.6	69.6	74.6	80.6	259
...	31.7	36.9	42.0	52.1	57.2	62.2	68.3	260
■ 0.81	0.82	0.85	0.88	0.89	0.88	0.90	0.93	0.98	0.99	1.01	1.02	1.05	1.06	1.07	1.08	261
...	...	15.5	19.6	21.6	24.2	29.2	34.2	46.8	54.3	59.3	64.3	74.3	79.3	84.3	90.3	261
...	...	14.5	18.6	20.6	23.2	28.2	33.2	45.8	53.3	58.3	63.3	73.3	78.4	83.4	89.4	262
14.1	15.6	19.2	23.2	25.2	27.7	32.7	37.7	50.3	57.8	62.8	67.8	77.8	82.8	87.8	93.8	263
13.3	14.9	18.4	22.5	24.5	27.0	32.0	37.0	49.5	57.1	62.1	67.1	77.1	82.1	87.1	93.1	264
...	...	12.9	16.4	20.5	22.5	25.0	30.1	47.6	55.1	60.2	65.2	75.2	80.2	85.2	91.2	265
■ 0.80	0.80	0.83	0.86	0.87	0.89	0.91	0.94	0.98	1.01	1.02	1.03	1.06	1.07	1.08	1.09	266
15.4	16.9	20.5	24.5	26.5	29.0	34.0	39.0	51.5	59.0	64.0	69.0	79.0	84.1	89.1	95.1	266
14.8	16.3	19.8	23.9	25.9	28.4	33.4	38.4	50.9	58.4	63.4	68.5	78.5	83.5	88.5	94.5	267
12.2	13.8	17.3	21.4	23.4	25.9	31.0	36.0	48.5	56.0	61.0	66.0	76.0	81.0	86.0	92.1	268
...	17.4	19.5	22.0	27.1	32.1	44.7	52.2	57.2	62.2	72.2	77.2	82.2	88.2	269
...	16.2	18.2	20.8	25.8	30.9	43.5	51.0	56.0	61.0	71.0	76.0	81.1	87.1	270
■ 0.80	0.81	0.84	0.86	0.87	0.88	0.91	0.94	0.98	1.01	1.02	1.03	1.06	1.07	1.08	1.09	271
...	21.4	34.2	41.8	46.8	51.9	61.9	66.9	72.0	78.0	271
...	28.7	36.3	41.4	46.5	56.6	61.6	66.6	72.7	272
...	34.6	44.9	50.0	55.1	61.2	273
...	17.4	22.6	27.6	40.3	47.8	52.8	57.9	67.9	72.9	77.9	83.9	274
15.8	17.3	20.8	24.9	26.9	29.4	34.4	39.4	51.9	59.4	64.4	69.4	79.4	84.4	89.4	95.4	275
■ 0.81	0.82	0.85	0.87	0.88	0.87	0.90	0.91	0.96	0.99	1.00	1.01	1.04	1.05	1.06	1.07	276
13.0	14.5	18.1	22.1	24.1	26.6	31.7	36.7	49.2	56.7	61.7	66.7	76.8	81.8	86.8	92.8	276
...	19.5	24.7	37.4	44.9	50.0	55.0	65.0	70.0	75.1	81.1	277
...	17.6	22.7	27.8	40.5	48.0	53.0	58.0	68.1	73.1	78.1	84.1	278
...	21.7	34.5	42.1	47.2	52.2	62.3	67.3	72.3	78.3	279
...	...	14.8	18.9	20.9	23.5	28.5	33.5	46.1	53.6	58.6	63.6	73.7	78.7	83.7	89.7	280
■ 0.79	0.80	0.82	0.85	0.87	0.87	0.89	0.91	0.97	0.99	1.01	1.02	1.05	1.06	1.07	1.08	281
...	...	15.8	19.9	21.9	24.4	29.5	34.5	47.1	54.6	59.6	64.6	74.6	79.6	84.6	90.6	281
13.6	15.1	18.6	22.7	24.7	27.2	32.2	37.2	49.8	57.3	62.3	67.3	77.3	82.3	87.3	93.3	282
15.0	16.5	20.0	24.1	26.1	28.6	33.6	38.6	51.1	58.6	63.6	68.6	78.6	83.7	88.7	94.7	283
...	32.4	37.6	42.7	52.8	57.9	62.9	69.0	284
14.3	15.8	19.4	23.4	25.4	27.9	33.0	38.0	50.5	58.0	63.0	68.0	78.0	83.0	88.0	94.0	285
■ 0.80	0.81	0.83	0.86	0.88	0.89	0.92	0.94	0.98	0.99	1.01	1.02	1.05	1.06	1.07	1.08	286
15.6	17.1	20.6	24.7	26.7	29.2	34.2	39.2	51.7	59.2	64.2	69.2	79.2	84.2	89.2	95.2	286
...	...	13.6	17.7	19.7	22.3	27.4	32.4	45.0	52.5	57.5	62.5	72.5	77.5	82.5	88.6	287
...	...	13.1	16.7	20.8	22.8	25.3	30.4	47.9	55.5	60.5	65.5	75.5	80.5	85.5	91.5	288
...	29.2	36.9	42.0	47.1	57.2	62.2	67.2	73.3	289
...	16.5	18.6	21.1	26.2	31.3	43.8	51.4	56.4	61.4	71.4	76.4	81.4	87.4	290
■ 0.80	0.80	0.82	0.85	0.86	0.88	0.91	0.93	0.97	1.00	1.01	1.02	1.05	1.06	1.07	1.08	291
12.5	14.1	17.6	21.7	23.7	26.2	31.3	36.3	48.8	56.3	61.3	66.3	76.3	81.4	86.4	92.4	291
...	22.0	34.8	42.4	47.5	52.5	62.6	67.6	72.6	78.6	292
13.2	14.7	18.3	22.3	24.3	26.9	31.9	36.9	49.4	57.0	62.0	67.0	77.0	82.0	87.0	93.0	293
...	19.9	25.0	37.8	45.3	50.4	55.4	65.4	70.5	75.5	81.5	294
...	17.9	23.1	28.2	40.8	48.4	53.4	58.4	68.4	73.5	78.5	84.5	295
■ 0.78	0.80	0.83	0.86	0.87	0.87	0.89	0.91	0.97	0.99	1.01	1.02	1.05	1.06	1.07	1.08	296
14.5	16.0	19.6	23.6	25.6	28.1	33.1	38.2	50.7	58.2	63.2	68.2	78.2	83.2	88.2	94.2	296
15.2	16.7	20.2	24.2	26.3	28.8	33.8	38.8	51.3	58.8	63.8	68.8	78.8	83.8	88.8	94.8	297
...	...	15.1	19.2	21.2	23.7	28.8	33.8	46.4	53.9	58.9	63.9	74.0	79.0	84.0	90.0	298
13.8	15.3	18.9	22.9	24.9	27.4	32.5	37.5	50.0	57.5	62.5	67.5	77.5	82.5	87.5	93.5	299
...	...	12.5	16.1	20.2	22.2	24.7	29.8	47.4	54.9	59.9	64.9	74.9	79.9	84.9	90.9	300
■ 0.79	0.80	0.83	0.86	0.87	0.89	0.91	0.94	0.98	1.01	1.02	1.03	1.06	1.07	1.08	1.09	

▲ Not all available belt lengths are shown.

■ Combined Arc-Length correction factors for 5 preceding lines.



5VX & 5V BELTS IN 5V SHEAVES

LINE #	RATIO	STOCK SHEAVES			DRIVEN SPEEDS AND HORSEPOWER RATINGS PER BELT								
		Datum Diameter		Number Grooves	1160 RPM			1750 RPM			3500 RPM		
		DR	DN		Driven Speed	H.P. Ratings		Driven Speed	H.P. Ratings		Driven Speed	H.P. Ratings	
						5VX	5V		5VX	5V		5VX	5V
301	2.24	6.70	15.00	2-6	518	14.47	11.81	782	20.60	16.31	1563	34.61	23.64
302	2.24	12.50	28.00	2-10	518	31.46	27.97	781	43.63	36.93
303	2.25	14.00	31.50	3-10	516	35.54	31.70	778	48.71	40.95
304	2.25	7.10	16.00	2-10	515	15.70	13.00	777	22.34	17.95	1553	37.24	25.66
305	2.27	5.20	11.80	2-6	511	9.78	7.22	771	13.89	9.89	1542	23.76	14.57
306	2.27	5.50	12.50	2-6	510	10.73	8.15	770	15.25	11.20	1540	26.05	16.56
307	2.29	10.30	23.60	2-10	506	25.24	22.15	764	35.49	30.00
308	2.29	9.25	21.20	2-10	506	22.17	19.24	764	31.33	26.28
309	2.31	4.90	11.30	2-6	503	8.82	6.28	759	12.52	8.56	1518	21.42	12.49
310	2.34	8.00	18.70	2-10	496	18.45	15.66	749	26.19	21.56
311	2.34	4.40	10.30	2-6	496	7.22	4.71	748	10.20	6.31	1495	17.40	8.86
312	2.34	16.00	37.50	3-10	495	40.76	36.35
313	2.34	4.65	10.90	2-6	495	8.02	5.50	747	11.36	7.44	1493	19.43	10.71
314	2.36	9.00	21.20	2-10	492	21.44	18.54	743	30.33	25.37
315	2.37	5.90	14.00	2-6	489	11.99	9.39	738	17.06	12.94	1475	29.03	19.11
316	2.37	11.80	28.00	2-10	489	29.52	26.17	738	41.14	34.87
317	2.38	6.30	15.00	2-6	487	13.24	10.61	735	18.85	14.65	1470	31.88	21.48
318	2.39	13.20	31.50	3-10	486	33.39	29.75	733	46.06	38.90
319	2.39	6.70	16.00	2-6	486	14.48	11.82	733	20.61	16.32	1466	34.63	23.68
320	2.40	5.50	13.20	2-6	483	10.73	8.16	729	15.26	11.21	1458	26.07	16.59
321	2.40	5.20	12.50	2-6	483	9.78	7.23	728	13.90	9.90	1456	23.78	14.59
322	2.41	4.90	11.80	2-6	482	8.83	6.29	727	12.52	8.57	1453	21.43	12.52
323	2.42	9.75	23.60	2-10	479	23.65	20.65	723	33.34	28.09
324	2.43	4.65	11.30	2-6	477	8.03	5.51	720	11.37	7.45	1440	19.44	10.72
325	2.48	4.40	10.90	2-6	468	7.23	4.72	706	10.21	6.33	1413	17.41	8.88
326	2.48	11.30	28.00	2-10	468	28.11	24.86	706	39.30	33.32
327	2.49	7.50	18.70	2-10	465	16.94	14.20	702	24.08	19.59
328	2.49	8.50	21.20	2-10	465	19.96	17.12	702	28.28	23.50
329	2.50	15.00	37.50	3-10	464	38.19	34.09
330	2.52	12.50	31.50	3-10	460	31.47	27.99	694	43.65	36.96
331	2.54	4.65	11.80	2-6	457	8.03	5.51	690	11.38	7.46	1379	19.45	10.74
332	2.54	5.20	13.20	2-6	457	9.79	7.24	689	13.91	9.91	1379	23.79	14.62
333	2.54	6.30	16.00	2-6	457	13.25	10.62	689	18.86	14.66	1378	31.90	21.51
334	2.54	5.90	15.00	2-6	456	12.00	9.40	688	17.07	12.96	1377	29.05	19.14
335	2.55	5.50	14.00	2-6	456	10.74	8.17	688	15.27	11.23	1375	26.08	16.61
336	2.55	4.90	12.50	2-6	455	8.83	6.30	686	12.53	8.58	1372	21.45	12.54
337	2.55	9.25	23.60	2-10	455	22.19	19.25	686	31.35	26.30
338	2.57	4.40	11.30	2-6	452	7.23	4.72	681	10.22	6.33	1363	17.42	8.90
339	2.57	10.90	28.00	2-10	452	26.98	23.80	681	37.81	32.03
340	2.62	9.00	23.60	2-10	442	21.45	18.55	667	30.34	25.39
341	2.63	7.10	18.70	2-10	440	15.72	13.03	664	22.36	17.99	1329	37.29	25.73
342	2.65	8.00	21.20	2-10	438	18.46	15.68	660	26.20	21.58
343	2.67	11.80	31.50	3-10	435	29.53	26.19	656	41.15	34.89
344	2.67	18.70	50.00	3-10	434	47.37	41.97
345	2.68	14.00	37.50	3-10	433	35.56	31.73	653	48.74	40.98
346	2.68	4.40	11.80	2-6	433	7.23	4.73	653	10.22	6.34	1305	17.44	8.91
347	2.69	4.65	12.50	2-6	432	8.04	5.52	651	11.38	7.47	1302	19.47	10.76
348	2.69	5.20	14.00	2-6	431	9.79	7.24	650	13.91	9.92	1300	23.81	14.63
349	2.69	4.90	13.20	2-6	431	8.84	6.30	650	12.54	8.59	1299	21.46	12.56
350	2.71	5.90	16.00	2-6	428	12.00	9.40	645	17.08	12.97	1291	29.06	19.16

Shaded area diameters are below industry standard for belt.

DRIVE SELECTION TABLES



CENTER DISTANCE AND COMBINED ARC-LENGTH CORRECTION FACTOR ▲

CENTER DISTANCE AND COMBINED ARC-LENGTH CORRECTION FACTOR ▲															LINE #	
5VX 630	5VX 710	5VX 750	5VX 800	5VX 900	5VX 1000	5VX 1250	5VX 1400	5VX 1500	5VX 1600	5VX 1800	5VX 1900	5VX 2000	5V 2120	5V 2240	5V 2500	
13.8	18.0	20.0	22.6	27.6	32.7	45.3	52.8	57.8	62.8	72.8	77.8	82.9	88.9	94.9	107.9	301
...	29.7	37.4	42.5	47.6	57.7	62.7	67.7	73.8	79.8	92.9	302
...	33.1	38.3	43.4	53.5	58.6	63.7	69.7	75.8	88.8	303
...	16.8	18.8	21.4	26.5	31.5	44.1	51.7	56.7	61.7	71.7	76.7	81.7	87.7	93.8	106.8	304
17.8	21.9	23.9	26.4	31.5	36.5	49.0	56.6	61.6	66.6	76.6	81.6	86.6	92.6	98.6	111.6	305
■ 0.81	0.84	0.86	0.87	0.90	0.93	0.96	0.98	1.00	1.01	1.04	1.05	1.06	1.08	1.09	1.11	■
17.0	21.1	23.1	25.6	30.7	35.7	48.2	55.8	60.8	65.8	75.8	80.8	85.8	91.8	97.8	110.8	306
...	22.4	35.2	42.9	47.9	53.0	63.0	68.1	73.1	79.1	85.1	98.1	307
...	20.2	25.4	38.1	45.7	50.7	55.8	65.8	70.8	75.8	81.9	87.9	100.9	308
18.5	22.5	24.6	27.1	32.1	37.1	49.7	57.2	62.2	67.2	77.2	82.2	87.2	93.2	99.2	112.2	309
...	18.2	23.4	28.5	41.2	48.7	53.8	58.8	68.8	73.8	78.8	84.9	90.9	103.9	310
■ 0.83	0.86	0.87	0.87	0.89	0.91	0.97	0.99	1.01	1.02	1.05	1.06	1.07	1.08	1.09	1.11	■
19.7	23.8	25.8	28.3	33.3	38.3	50.9	58.4	63.4	68.4	78.4	83.4	88.4	94.4	100.4	113.4	311
...	31.1	36.4	46.7	51.9	57.0	63.1	69.1	82.3	312
19.0	23.1	25.1	27.6	32.6	37.7	50.2	57.7	62.7	67.7	77.7	82.7	87.7	93.7	99.7	112.7	313
...	20.4	25.6	38.3	45.9	50.9	55.9	66.0	71.0	76.0	82.1	88.1	101.1	314
15.3	19.4	21.5	24.0	29.1	34.1	46.7	54.2	59.2	64.2	74.3	79.3	84.3	90.3	96.3	109.3	315
■ 0.83	0.86	0.87	0.89	0.90	0.92	0.98	1.00	1.00	1.01	1.04	1.05	1.06	1.08	1.09	1.11	■
...	30.2	37.9	43.0	48.1	58.2	63.2	68.3	74.3	80.3	93.4	316
14.1	18.3	20.3	22.9	27.9	33.0	45.6	53.1	58.1	63.1	73.1	78.1	83.2	89.2	95.2	108.2	317
...	25.8	33.6	38.8	43.9	54.1	59.2	64.2	70.3	76.3	89.4	318
...	17.0	19.1	21.7	26.8	31.8	44.4	52.0	57.0	62.0	72.0	77.0	82.0	88.0	94.1	107.1	319
16.4	20.5	22.5	25.0	30.1	35.1	47.7	55.2	60.2	65.2	75.2	80.2	85.2	91.2	97.2	110.2	320
■ 0.80	0.83	0.85	0.87	0.90	0.92	0.95	0.98	1.00	1.01	1.04	1.05	1.06	1.08	1.09	1.11	■
17.2	21.3	23.3	25.8	30.9	35.9	48.5	56.0	61.0	66.0	76.0	81.0	86.0	92.0	98.0	111.0	321
18.1	22.1	24.1	26.7	31.7	36.7	49.3	56.8	61.8	66.8	76.8	81.8	86.8	92.8	98.8	111.8	322
...	22.8	35.6	43.3	48.3	53.4	63.4	68.5	73.5	79.5	85.5	98.6	323
18.7	22.7	24.7	27.3	32.3	37.3	49.9	57.4	62.4	67.4	77.4	82.4	87.4	93.4	99.4	112.4	324
19.2	23.3	25.3	27.8	32.8	37.8	50.4	57.9	62.9	67.9	77.9	82.9	87.9	93.9	99.9	112.9	325
■ 0.83	0.86	0.87	0.89	0.91	0.92	0.97	1.00	1.01	1.03	1.05	1.06	1.07	1.08	1.10	1.12	■
...	30.5	38.2	43.3	48.4	58.5	63.6	68.6	74.7	80.7	93.8	326
...	...	15.9	18.6	23.8	28.9	41.5	49.1	54.1	59.2	69.2	74.2	79.2	85.2	91.3	104.3	327
...	20.7	25.9	38.7	46.2	51.3	56.3	66.4	71.4	76.4	82.4	88.4	101.5	328
...	31.8	37.1	47.4	52.6	57.7	63.8	69.9	83.0	329
...	26.2	34.1	39.3	44.4	54.6	59.7	64.7	70.8	76.9	89.9	330
■		0.81	0.83	0.86	0.90	0.93	0.97	0.97	0.99	1.02	1.04	1.05	1.06	1.08	1.10	■
18.2	22.3	24.3	26.8	31.9	36.9	49.5	57.0	62.0	67.0	77.0	82.0	87.0	93.0	99.0	112.0	331
16.6	20.7	22.7	25.2	30.3	35.3	47.9	55.4	60.4	65.4	75.4	80.4	85.5	91.5	97.5	110.5	332
...	17.3	19.4	21.9	27.1	32.1	44.7	52.3	57.3	62.3	72.3	77.3	82.3	88.4	94.4	107.4	333
14.4	18.5	20.6	23.1	28.2	33.3	45.9	53.4	58.4	63.4	73.4	78.5	83.5	89.5	95.5	108.5	334
15.6	19.7	21.8	24.3	29.4	34.4	47.0	54.5	59.5	64.5	74.6	79.6	84.6	90.6	96.6	109.6	335
■ 0.81	0.84	0.85	0.87	0.90	0.93	0.98	1.00	1.01	1.03	1.05	1.06	1.07	1.08	1.10	1.12	■
17.4	21.5	23.5	26.1	31.1	36.1	48.7	56.2	61.2	66.2	76.2	81.2	86.3	92.3	98.3	111.3	336
...	23.1	36.0	43.6	48.7	53.7	63.8	68.8	73.9	79.9	85.9	98.9	337
18.9	22.9	24.9	27.5	32.5	37.5	50.1	57.6	62.6	67.6	77.6	82.6	87.6	93.6	99.6	112.6	338
...	30.8	38.5	43.6	48.7	58.8	63.9	68.9	75.0	81.0	94.1	339
...	23.2	36.2	43.8	48.9	53.9	64.0	69.0	74.0	80.1	86.1	99.1	340
■ 0.82	0.85	0.87	0.88	0.91	0.90	0.95	0.98	1.00	1.01	1.04	1.05	1.06	1.08	1.09	1.11	■
...	...	16.2	18.8	24.0	29.2	41.8	49.4	54.4	59.5	69.5	74.5	79.5	85.5	91.6	104.6	341
...	21.0	26.2	39.0	46.6	51.6	56.7	66.7	71.8	76.8	82.8	88.8	101.9	342
...	26.7	34.6	39.8	44.9	55.1	60.2	65.2	71.3	77.4	90.5	343
...	37.8	43.2	49.6	55.9	69.3	344
...	32.4	37.7	48.1	53.3	58.4	64.5	70.6	83.7	345
■		0.80	0.83	0.86	0.90	0.93	0.97	0.97	0.99	1.02	1.01	1.03	1.05	1.06	1.09	■
18.4	22.5	24.5	27.0	32.1	37.1	49.6	57.2	62.2	67.2	77.2	82.2	87.2	93.2	99.2	112.2	346
17.6	21.7	23.7	26.2	31.3	36.3	48.9	56.4	61.4	66.4	76.4	81.4	86.4	92.4	98.5	111.5	347
15.8	19.9	22.0	24.5	29.6	34.6	47.2	54.7	59.8	64.8	74.8	79.8	84.8	90.8	96.8	109.8	348
16.8	20.9	22.9	25.4	30.5	35.5	48.1	55.6	60.6	65.7	75.7	80.7	85.7	91.7	97.7	110.7	349
...	17.6	19.7	22.2	27.3	32.4	45.0	52.6	57.6	62.6	72.6	77.6	82.6	88.7	94.7	107.7	350
■ 0.81	0.84	0.86	0.87	0.90	0.93	0.98	1.00	1.01	1.03	1.05	1.06	1.07	1.08	1.10	1.12	■

▲ Not all available belt lengths are shown.

■ Combined Arc-Length correction factors for 5 preceding lines.



5VX & 5V BELTS IN 5V SHEAVES

LINE #	RATIO	STOCK SHEAVES			DRIVEN SPEEDS AND HORSEPOWER RATINGS PER BELT								
		Datum Diameter		Number Grooves	1160 RPM			1750 RPM			3500 RPM		
		DR	DN		Driven Speed	H.P. Ratings		Driven Speed	H.P. Ratings		Driven Speed	H.P. Ratings	
						5VX	5V		5VX	5V		5VX	5V
351	2.72	10.30	28.00	2-10	427	25.26	22.18	644	35.51	30.03
352	2.73	5.50	15.00	2-6	425	10.74	8.17	642	15.28	11.24	1283	26.10	16.64
353	2.78	8.50	23.60	2-10	418	19.97	17.13	630	28.30	23.52
354	2.79	11.30	31.50	3-10	416	28.12	24.88	628	39.32	33.34
355	2.79	6.70	18.70	2-6	416	14.49	11.83	627	20.63	16.35	1254	34.67	23.73
356	2.83	7.50	21.20	2-10	410	16.95	14.22	619	24.09	19.61
357	2.84	4.65	13.20	2-6	409	8.04	5.52	616	11.39	7.48	1233	19.48	10.78
358	2.84	4.40	12.50	2-6	408	7.24	4.73	616	10.23	6.35	1232	17.45	8.93
359	2.84	13.20	37.50	3-10	408	33.40	29.77	616	46.09	38.93
360	2.86	4.90	14.00	2-6	406	8.84	6.31	613	12.55	8.60	1225	21.48	12.57
361	2.87	9.75	28.00	2-10	404	23.66	20.66	609	33.36	28.12
362	2.88	5.20	15.00	2-6	402	9.80	7.25	607	13.92	9.93	1213	23.82	14.65
363	2.89	10.90	31.50	3-10	401	26.99	23.81	606	37.82	32.05
364	2.91	5.50	16.00	2-6	399	10.75	8.18	602	15.29	11.25	1203	26.11	16.65
365	2.95	8.00	23.60	2-10	393	18.47	15.69	593	26.22	21.60
366	2.97	6.30	18.70	2-6	391	13.26	10.63	590	18.87	14.68	1179	31.94	21.55
367	2.99	7.10	21.20	2-10	388	15.73	13.04	586	22.38	18.00	1172	37.32	25.76
368	3.00	4.40	13.20	2-6	387	7.24	4.74	583	10.23	6.35	1167	17.46	8.94
369	3.00	12.50	37.50	3-10	387	31.49	28.01	583	43.67	36.99
370	3.01	4.65	14.00	2-6	385	8.04	5.53	581	11.40	7.48	1163	19.49	10.79
371	3.03	9.25	28.00	2-10	383	22.20	19.27	578	31.37	26.33
372	3.06	10.30	31.50	3-10	379	25.27	22.19	572	35.53	30.04
373	3.06	4.90	15.00	2-6	379	8.85	6.31	572	12.55	8.61	1143	21.49	12.59
374	3.08	5.20	16.00	2-6	377	9.80	7.25	569	13.93	9.94	1138	23.83	14.67
375	3.11	9.00	28.00	2-10	373	21.46	18.56	563	30.36	25.41
376	3.13	16.00	50.00	3-10	371	40.78	36.38
377	3.15	7.50	23.60	2-10	369	16.95	14.22	556	24.10	19.62
378	3.16	6.70	21.20	2-6	367	14.50	11.84	553	20.64	16.36	1106	34.69	23.76
379	3.17	5.90	18.70	2-6	366	12.01	9.42	552	17.10	12.99	1104	29.09	19.20
380	3.18	11.80	37.50	3-10	365	29.54	26.20	551	41.17	34.91
381	3.18	4.40	14.00	2-6	365	7.24	4.74	550	10.24	6.36	1100	17.47	8.95
382	3.23	4.65	15.00	2-6	360	8.05	5.53	543	11.40	7.49	1085	19.50	10.80
383	3.23	9.75	31.50	3-10	359	23.67	20.67	542	33.37	28.13
384	3.27	4.90	16.00	2-6	355	8.85	6.32	536	12.56	8.61	1072	21.50	12.60
385	3.29	8.50	28.00	2-10	352	19.97	17.14	531	28.31	23.54
386	3.32	11.30	37.50	3-10	350	28.13	24.89	527	39.33	33.35
387	3.32	7.10	23.60	2-10	349	15.73	13.04	526	22.38	18.01	1053	37.33	25.78
388	3.33	15.00	50.00	3-10	348	38.21	34.11
389	3.37	6.30	21.20	2-6	345	13.26	10.64	520	18.88	14.69	1040	31.96	21.57
390	3.40	5.50	18.70	2-6	341	10.76	8.19	515	15.30	11.26	1029	26.14	16.68
391	3.41	9.25	31.50	3-10	341	22.20	19.28	514	31.38	26.34
392	3.41	4.40	15.00	2-6	340	7.25	4.74	513	10.24	6.37	1027	17.48	8.96
393	3.44	10.90	37.50	3-10	337	27.00	23.82	509	37.83	32.06
394	3.44	4.65	16.00	2-6	337	8.05	5.53	509	11.40	7.50	1017	19.51	10.81
395	3.50	8.00	28.00	2-10	331	18.47	15.70	500	26.23	21.61
396	3.50	9.00	31.50	3-10	331	21.47	18.57	500	30.37	25.42
397	3.52	6.70	23.60	2-6	329	14.50	11.85	497	20.65	16.37	994	34.71	23.77
398	3.57	14.00	50.00	3-10	325	35.57	31.75	490	48.76	41.01
399	3.59	5.90	21.20	2-6	323	12.02	9.42	487	17.10	12.99	974	29.11	19.22
400	3.60	5.20	18.70	2-6	323	9.81	7.26	487	13.94	9.95	973	23.85	14.69

Shaded area diameters are below industry standard for belt.

DRIVE SELECTION TABLES



CENTER DISTANCE AND COMBINED ARC-LENGTH CORRECTION FACTOR ▲																LINE #
5VX 750	5VX 800	5VX 900	5VX 1000	5VX 1250	5VX 1400	5VX 1500	5VX 1600	5VX 1800	5VX 1900	5VX 2000	5V 2120	5V 2240	5V 2500	5V 2800	5V 3150	
...	31.2	38.9	44.0	49.1	59.3	64.3	69.4	75.4	81.4	94.5	109.6	127.1	351
20.9	23.4	28.5	33.6	46.2	53.7	58.7	63.7	73.7	78.8	83.8	89.8	95.8	108.8	123.8	141.3	352
...	23.6	36.5	44.1	49.2	54.3	64.3	69.4	74.4	80.4	86.5	99.5	114.5	132.1	353
...	27.0	34.9	40.1	45.3	55.5	60.5	65.6	71.7	77.7	90.8	105.9	123.5	354
16.5	19.1	24.3	29.4	42.1	49.7	54.7	59.7	69.8	74.8	79.8	85.8	91.9	104.9	119.9	137.4	355
■ 0.82	0.85	0.88	0.90	0.93	0.97	0.99	1.00	1.03	1.04	1.06	1.07	1.08	1.11	1.13	1.15	
...	...	21.4	26.6	39.4	47.0	52.0	57.0	67.1	72.1	77.2	83.2	89.2	102.2	117.3	134.8	356
23.1	25.6	30.7	35.7	48.3	55.8	60.8	65.8	75.9	80.9	85.9	91.9	97.9	110.9	125.9	143.4	357
23.9	26.4	31.5	36.5	49.1	56.6	61.6	66.6	76.6	81.6	86.6	92.6	98.6	111.7	126.7	144.2	358
...	32.9	38.3	48.7	53.8	58.9	65.0	71.1	84.3	99.4	117.0	359
22.2	24.7	29.8	34.9	47.4	55.0	60.0	65.0	75.0	80.0	85.0	91.0	97.0	110.1	125.1	142.6	360
■ 0.86	0.87	0.89	0.92	0.97	1.00	0.99	1.01	1.04	1.05	1.06	1.07	1.09	1.11	1.13	1.16	
...	31.5	39.3	44.4	49.5	59.7	64.7	69.8	75.8	81.8	94.9	110.0	127.5	361
21.1	23.6	28.7	33.8	46.4	53.9	58.9	63.9	74.0	79.0	84.0	90.0	96.0	109.0	124.0	141.6	362
...	27.3	35.2	40.4	45.5	55.7	60.8	65.9	72.0	78.0	91.1	106.2	123.8	363
19.9	22.5	27.6	32.7	45.3	52.9	57.9	62.9	72.9	77.9	82.9	89.0	95.0	108.0	123.0	140.5	364
...	...	18.5	23.9	36.9	44.5	49.6	54.6	64.7	69.7	74.8	80.8	86.8	99.9	114.9	132.5	365
■ 0.84	0.86	0.86	0.90	0.93	0.97	0.99	1.00	1.03	1.04	1.06	1.07	1.08	1.11	1.13	1.15	
16.7	19.4	24.6	29.7	42.4	50.0	55.0	60.0	70.1	75.1	80.1	86.1	92.2	105.2	120.2	137.7	366
...	...	21.6	26.8	39.6	47.2	52.3	57.3	67.4	72.4	77.5	83.5	89.5	102.5	117.6	135.1	367
23.3	25.8	30.9	35.9	48.5	56.0	61.0	66.0	76.0	81.1	86.1	92.1	98.1	111.1	126.1	143.6	368
...	27.9	33.4	38.7	49.1	54.3	59.4	65.5	71.6	84.8	99.9	117.6	369
22.4	24.9	30.0	35.0	47.6	55.2	60.2	65.2	75.2	80.2	85.2	91.2	97.2	110.3	125.3	142.8	370
■ 0.84	0.86	0.88	0.91	0.96	0.97	0.99	1.00	1.03	1.05	1.06	1.07	1.08	1.11	1.13	1.15	
...	31.9	39.6	44.8	49.9	60.0	65.1	70.1	76.2	82.2	95.3	110.3	127.9	371
...	27.6	35.6	40.8	45.9	56.2	61.3	66.3	72.4	78.5	91.6	106.6	124.2	372
21.3	23.8	28.9	34.0	46.6	54.1	59.2	64.2	74.2	79.2	84.2	90.2	96.2	109.3	124.3	141.8	373
20.1	22.7	27.8	32.9	45.5	53.1	58.1	63.1	73.2	78.2	83.2	89.2	95.2	108.2	123.2	140.7	374
...	32.0	39.8	44.9	50.0	60.2	65.2	70.3	76.3	82.4	95.5	110.5	128.1	375
■ 0.84	0.86	0.89	0.92	0.93	0.96	0.98	1.00	1.03	1.04	1.05	1.07	1.08	1.10	1.13	1.15	
...	39.5	44.9	51.3	57.7	71.1	86.5	104.3	376	
...	...	18.9	24.2	37.2	44.9	49.9	55.0	65.1	70.1	75.1	81.2	87.2	100.3	115.3	132.8	377
...	16.5	21.9	27.1	39.9	47.5	52.6	57.6	67.7	72.7	77.7	83.8	89.8	102.8	117.9	135.4	378
17.0	19.6	24.9	30.0	42.7	50.3	55.3	60.3	70.4	75.4	80.4	86.4	92.5	105.5	120.5	138.0	379
...	28.4	33.8	39.2	49.6	54.8	59.9	66.0	72.1	85.3	100.5	118.1	380
■ 0.80	0.80	0.84	0.88	0.95	0.95	0.97	0.99	1.02	1.01	1.03	1.05	1.06	1.09	1.12	1.14	
22.5	25.1	30.2	35.2	47.8	55.3	60.4	65.4	75.4	80.4	85.4	91.4	97.4	110.4	125.5	143.0	381
21.4	24.0	29.1	34.2	46.8	54.3	59.3	64.4	74.4	79.4	84.4	90.4	96.4	109.4	124.5	142.0	382
...	28.0	36.0	41.2	46.3	56.6	61.6	66.7	72.8	78.9	92.0	107.0	124.6	383
20.3	22.9	28.0	33.1	45.7	53.3	58.3	63.3	73.4	78.4	83.4	89.4	95.4	108.4	123.5	141.0	384
...	32.4	40.1	45.3	50.4	60.5	65.6	70.7	76.7	82.8	95.8	110.9	128.5	385
■ 0.84	0.86	0.89	0.92	0.94	0.97	0.99	1.01	1.03	1.05	1.06	1.07	1.08	1.11	1.13	1.15	
...	28.7	34.2	39.5	50.0	55.1	60.2	66.4	72.5	85.7	100.8	118.4	386
...	...	19.1	24.5	37.5	45.1	50.2	55.3	65.4	70.4	75.4	81.5	87.5	100.5	115.6	133.1	387
...	40.1	45.6	52.0	58.3	71.8	87.2	105.0	388	
...	16.7	22.1	27.4	40.2	47.8	52.9	57.9	68.0	73.0	78.0	84.1	90.1	103.1	118.2	135.7	389
17.2	19.9	25.1	30.3	43.0	50.6	55.6	60.6	70.7	75.7	80.7	86.7	92.8	105.8	120.8	138.3	390
■ 0.79	0.80	0.84	0.88	0.95	0.95	0.97	0.99	1.02	1.01	1.03	1.05	1.06	1.09	1.12	1.14	
...	28.3	36.3	41.5	46.7	56.9	62.0	67.1	73.1	79.2	92.3	107.4	125.0	391
21.6	24.2	29.3	34.4	47.0	54.5	59.5	64.5	74.6	79.6	84.6	90.6	96.6	109.6	124.7	142.2	392
...	28.9	34.4	39.8	50.2	55.4	60.5	66.7	72.8	86.0	101.1	118.7	393
20.5	23.1	28.2	33.3	45.9	53.5	58.5	63.5	73.6	78.6	83.6	89.6	95.6	108.6	123.7	141.2	394
...	32.7	40.5	45.6	50.7	60.9	66.0	71.0	77.1	83.1	96.2	111.3	128.8	395
■ 0.84	0.86	0.89	0.92	0.93	0.94	0.97	0.99	1.02	1.03	1.05	1.06	1.07	1.10	1.12	1.15	
...	28.5	36.5	41.7	46.8	57.1	62.2	67.3	73.3	79.4	92.5	107.6	125.2	396
...	...	19.4	24.8	37.8	45.4	50.5	55.6	65.7	70.7	75.7	81.8	87.8	100.8	115.9	133.4	397
...	35.1	40.8	46.2	52.7	59.0	72.5	87.9	105.7	398
...	17.0	22.4	27.7	40.5	48.1	53.2	58.2	68.3	73.3	78.3	84.4	90.4	103.4	118.5	136.0	399
17.4	20.1	25.3	30.5	43.2	50.8	55.8	60.9	70.9	75.9	80.9	87.0	93.0	106.0	121.0	138.6	400
■ 0.79	0.80	0.83	0.88	0.93	0.96	0.98	1.00	1.00	1.02	1.03	1.05	1.06	1.09	1.12	1.14	

▲ Not all available belt lengths are shown.
 ■ Combined Arc-Length correction factors for 5 preceding lines.



5VX & 5V BELTS IN 5V SHEAVES

LINE #	RATIO	STOCK SHEAVES			DRIVEN SPEEDS AND HORSEPOWER RATINGS PER BELT								
		Datum Diameter		Number Grooves	1160 RPM			1750 RPM			3500 RPM		
		DR	DN		Driven Speed	H.P. Ratings		Driven Speed	H.P. Ratings		Driven Speed	H.P. Ratings	
						5VX	5V		5VX	5V		5VX	5V
401	3.64	4.40	16.00	2-6	319	7.25	4.75	481	10.24	6.37	963	17.48	8.97
402	3.64	10.30	37.50	3-10	319	25.27	22.20	481	35.54	30.06
403	3.71	8.50	31.50	3-10	313	19.98	17.14	472	28.32	23.54
404	3.73	7.50	28.00	2-10	311	16.96	14.23	469	24.11	19.64
405	3.75	6.30	23.60	2-6	310	13.27	10.64	467	18.89	14.70	934	31.97	21.59
406	3.79	13.20	50.00	3-10	306	33.42	29.78	462	46.11	38.95
407	3.82	4.90	18.70	2-6	304	8.85	6.33	459	12.56	8.62	917	21.51	12.62
408	3.85	9.75	37.50	3-10	302	23.68	20.68	455	33.38	28.14
409	3.85	5.50	21.20	2-6	301	10.76	8.19	454	15.30	11.27	908	26.15	16.70
410	3.94	8.00	31.50	3-10	295	18.48	15.70	444	26.23	21.62
411	3.94	7.10	28.00	2-10	294	15.74	13.05	444	22.39	18.02	888	37.35	25.80
412	4.00	5.90	23.60	2-6	290	12.02	9.43	438	17.11	13.00	875	29.12	19.23
413	4.00	12.50	50.00	3-10	290	31.50	28.02	438	43.69	37.01
414	4.02	4.65	18.70	2-6	288	8.05	5.54	435	11.41	7.51	870	19.52	10.83
415	4.05	9.25	37.50	3-10	286	22.21	19.28	432	31.39	26.35
416	4.08	5.20	21.20	2-6	285	9.81	7.27	429	13.94	9.96	858	23.86	14.71
417	4.17	9.00	37.50	3-10	278	21.47	18.58	420	30.37	25.43
418	4.18	6.70	28.00	2-6	278	14.51	11.86	419	20.65	16.38	837	34.72	23.79
419	4.20	7.50	31.50	3-10	276	16.96	14.24	417	24.11	19.64
420	4.24	11.80	50.00	3-10	274	29.55	26.21	413	41.18	34.93
421	4.25	4.40	18.70	2-6	273	7.25	4.75	412	10.25	6.38	824	17.49	8.99
422	4.29	5.50	23.60	2-6	270	10.76	8.20	408	15.31	11.27	816	26.16	16.71
423	4.33	4.90	21.20	2-6	268	8.86	6.33	404	12.57	8.63	809	21.52	12.63
424	4.41	8.50	37.50	3-10	263	19.98	17.15	397	28.32	23.55
425	4.42	11.30	50.00	3-10	262	28.14	24.90	396	39.34	33.37
426	4.44	7.10	31.50	3-10	261	15.74	13.05	394	22.40	18.03	789	37.36	25.81
427	4.44	6.30	28.00	2-6	261	13.27	10.65	394	18.89	14.71	788	31.98	21.60
428	4.54	5.20	23.60	2-6	256	9.81	7.27	386	13.95	9.96	771	23.87	14.72
429	4.56	4.65	21.20	2-6	254	8.06	5.54	384	11.42	7.51	768	19.53	10.84
430	4.59	10.90	50.00	3-10	253	27.00	23.83	381	37.84	32.08
431	4.69	8.00	37.50	3-10	247	18.48	15.70	373	26.24	21.63
432	4.70	6.70	31.50	3-6	247	14.51	11.86	372	20.66	16.38	744	34.73	23.80
433	4.75	5.90	28.00	2-6	244	12.02	9.43	369	17.11	13.01	738	29.13	19.24
434	4.82	4.90	23.60	2-6	241	8.86	6.33	363	12.57	8.63	727	21.53	12.64
435	4.82	4.40	21.20	2-6	241	7.25	4.75	363	10.25	6.38	726	17.50	9.00
436	4.85	10.30	50.00	3-10	239	25.28	22.20	361	35.55	30.07
437	5.00	6.30	31.50	3-6	232	13.27	10.65	350	18.90	14.71	700	31.99	21.61
438	5.00	7.50	37.50	3-10	232	16.97	14.24	350	24.12	19.65
439	5.08	4.65	23.60	2-6	229	8.06	5.55	345	11.42	7.51	690	19.54	10.85
440	5.09	5.50	28.00	2-6	228	10.76	8.20	344	15.31	11.28	688	26.17	16.72
441	5.13	9.75	50.00	3-10	226	23.68	20.69	341	33.39	28.16
442	5.28	7.10	37.50	3-10	220	15.75	13.06	331	22.40	18.03	663	37.36	25.83
443	5.34	5.90	31.50	3-6	217	12.02	9.43	328	17.12	13.01	656	29.13	19.25
444	5.36	4.40	23.60	2-6	216	7.26	4.76	326	10.26	6.39	653	17.51	9.00
445	5.38	5.20	28.00	2-6	215	9.82	7.27	325	13.95	9.97	650	23.88	14.73
446	5.41	9.25	50.00	3-10	215	22.21	19.29	324	31.39	26.36
447	5.56	9.00	50.00	3-10	209	21.48	18.58	315	30.38	25.44
448	5.60	6.70	37.50	3-6	207	14.51	11.86	313	20.66	16.39	625	34.74	23.81
449	5.71	4.90	28.00	2-6	203	8.86	6.33	306	12.58	8.64	613	21.53	12.65
450	5.73	5.50	31.50	3-6	203	10.77	8.20	306	15.32	11.28	611	26.17	16.73

Shaded area diameters are below industry standard for belt.

DRIVE SELECTION TABLES



CENTER DISTANCE AND COMBINED ARC-LENGTH CORRECTION FACTOR ▲

CENTER DISTANCE AND COMBINED ARC-LENGTH CORRECTION FACTOR ▲																LINE #
5VX 900	5VX 1000	5VX 1250	5VX 1400	5VX 1500	5VX 1600	5VX 1800	5VX 1900	5VX 2000	5V 2120	5V 2240	5V 2500	5V 2800	5V 3150	5V 3350	5V 3550	
28.4	33.5	46.1	53.7	58.7	63.7	73.7	78.8	83.8	89.8	95.8	108.8	123.8	141.4	151.4	161.4	401
...	29.3	34.8	40.2	50.6	55.8	60.9	67.1	73.2	86.4	101.5	119.2	129.2	139.3	402
...	...	28.8	36.8	42.0	47.2	57.4	62.5	67.6	73.7	79.8	92.9	108.0	125.6	135.6	145.6	403
...	...	33.0	40.8	46.0	51.1	61.3	66.3	71.4	77.4	83.5	96.6	111.6	129.2	139.2	149.3	404
19.6	25.0	38.0	45.7	50.8	55.8	65.9	71.0	76.0	82.1	88.1	101.1	116.2	133.7	143.8	153.8	405
■ 0.84	0.88	0.92	0.94	0.96	0.98	1.02	1.03	1.04	1.06	1.07	1.10	1.12	1.15	1.16	1.17	406
...	35.6	41.3	46.7	53.2	59.5	73.0	88.4	106.3	116.4	126.5	406
25.5	30.7	43.4	51.0	56.0	61.1	71.1	76.2	81.2	87.2	93.2	106.2	121.3	138.8	148.8	158.8	407
...	29.6	35.2	40.5	51.0	56.2	61.3	67.5	73.6	86.8	101.9	119.6	129.6	139.7	408
22.7	27.9	40.8	48.4	53.5	58.5	68.6	73.6	78.6	84.7	90.7	103.7	118.8	136.3	146.3	156.3	409
...	...	29.1	37.1	42.3	47.5	57.8	62.9	68.0	74.0	80.1	93.2	108.3	125.9	136.0	146.0	410
■ 0.85	0.89	0.92	0.93	0.96	0.98	0.99	1.01	1.02	1.04	1.06	1.09	1.11	1.14	1.15	1.17	411
...	...	33.3	41.1	46.3	51.4	61.5	66.6	71.7	77.7	83.8	96.9	111.9	129.5	139.5	149.6	411
19.9	25.3	38.3	46.0	51.1	56.1	66.2	71.3	76.3	82.4	88.4	101.4	116.5	134.0	144.1	154.1	412
...	36.0	41.7	47.2	53.6	60.0	73.5	88.9	106.8	116.9	127.0	413
25.7	30.9	43.6	51.2	56.2	61.3	71.3	76.3	81.4	87.4	93.4	106.4	121.5	139.0	149.0	159.0	414
...	30.0	35.5	40.8	51.3	56.5	61.7	67.8	73.9	87.1	102.3	120.0	130.0	140.1	415
■ 0.83	0.87	0.93	0.94	0.96	0.98	0.99	1.01	1.02	1.04	1.06	1.09	1.11	1.14	1.15	1.17	416
22.9	28.1	41.0	48.6	53.7	58.7	68.8	73.8	78.9	84.9	90.9	104.0	119.0	136.5	146.5	156.6	416
...	30.1	35.6	41.0	51.5	56.7	61.8	68.0	74.1	87.3	102.5	120.1	130.2	140.3	417
...	19.9	33.6	41.4	46.5	51.6	61.8	66.9	72.0	78.0	84.1	97.2	112.2	129.8	139.8	149.9	418
...	...	29.4	37.4	42.7	47.9	58.1	63.2	68.3	74.4	80.5	93.6	108.7	126.3	136.3	146.4	419
...	36.5	42.1	47.6	54.1	60.4	74.0	89.4	107.3	117.4	127.5	420
■ 0.84	0.82	0.90	0.92	0.95	0.97	0.98	1.00	1.02	1.04	1.05	1.08	1.11	1.14	1.15	1.16	421
25.9	31.0	43.8	51.4	56.4	61.4	71.5	76.5	81.5	87.6	93.6	106.6	121.6	139.2	149.2	159.2	421
20.1	25.5	38.6	46.3	51.3	56.4	66.5	71.6	76.6	82.6	88.7	101.7	116.8	134.3	144.4	154.4	422
23.1	28.3	41.2	48.8	53.9	58.9	69.0	74.1	79.1	85.1	91.1	104.2	119.2	136.8	146.8	156.8	423
...	30.4	35.9	41.3	51.8	57.0	62.2	68.3	74.5	87.7	102.8	120.5	130.6	140.6	424
...	36.8	42.4	48.0	54.4	60.8	74.3	89.8	107.6	117.8	127.9	425
■ 0.83	0.87	0.94	0.94	0.97	0.99	0.99	1.01	1.03	1.04	1.06	1.09	1.11	1.14	1.15	1.17	426
...	...	29.7	37.7	43.0	48.1	58.4	63.5	68.6	74.7	80.8	93.9	109.0	126.6	136.6	146.7	426
...	20.1	33.8	41.6	46.8	51.9	62.1	67.2	72.2	78.3	84.4	97.5	112.5	130.1	140.1	150.2	427
20.3	25.7	38.8	46.5	51.6	56.6	66.7	71.8	76.8	82.9	88.9	102.0	117.0	134.6	144.6	154.6	428
23.2	28.5	41.4	49.0	54.1	59.1	69.2	74.2	79.3	85.3	91.3	104.4	119.4	136.9	147.0	157.0	429
...	37.0	42.7	48.2	54.7	61.0	74.6	90.0	107.9	118.1	128.2	430
■ 0.81	0.83	0.91	0.95	0.97	0.99	0.99	1.01	1.02	1.04	1.06	1.09	1.11	1.14	1.15	1.17	431
...	30.7	36.3	41.7	52.2	57.4	62.5	68.7	74.8	88.0	103.2	120.9	130.9	141.0	431
...	...	29.9	38.0	43.2	48.4	58.7	63.8	68.9	75.0	81.0	94.2	109.3	126.9	136.9	147.0	432
...	20.4	34.1	41.9	47.1	52.2	62.4	67.5	72.5	78.6	84.7	97.8	112.8	130.4	140.4	150.5	433
20.5	25.9	39.0	46.7	51.8	56.8	67.0	72.0	77.0	83.1	89.1	102.2	117.2	134.8	144.8	154.8	434
23.4	28.7	41.5	49.2	54.2	59.3	69.4	74.4	79.4	85.5	91.5	104.6	119.6	137.1	147.2	157.2	435
■ 0.81	0.83	0.91	0.93	0.95	0.98	1.01	1.02	1.04	1.05	1.07	1.09	1.12	1.14	1.16	1.17	436
...	37.4	43.1	48.6	55.1	61.4	75.0	90.5	108.3	118.5	128.6	436
...	...	30.2	38.2	43.5	48.7	59.0	64.1	69.2	75.3	81.3	94.5	109.6	127.2	137.2	147.3	437
...	31.0	36.6	42.0	52.5	57.7	62.9	69.0	75.2	88.4	103.6	121.2	131.3	141.4	438
20.6	26.1	39.2	46.9	51.9	57.0	67.1	72.2	77.2	83.3	89.3	102.4	117.4	135.0	145.0	155.0	439
...	20.6	34.3	42.2	47.4	52.5	62.7	67.8	72.8	78.9	84.9	98.0	113.1	130.7	140.7	150.8	440
■ 0.79	0.81	0.90	0.92	0.94	0.97	0.98	1.00	1.01	1.03	1.05	1.08	1.11	1.13	1.15	1.16	441
...	37.7	43.4	48.9	55.4	61.8	75.4	90.8	108.7	118.9	129.0	441
...	31.3	36.8	42.2	52.8	58.0	63.1	69.3	75.4	88.7	103.9	121.5	131.6	141.7	442
...	...	30.4	38.5	43.8	49.0	59.2	64.4	69.4	75.5	81.6	94.8	109.9	127.5	137.5	147.6	443
20.8	26.3	39.3	47.0	52.1	57.2	67.3	72.4	77.4	83.5	89.5	102.6	117.6	135.2	145.2	155.2	444
...	20.8	34.5	42.4	47.6	52.7	62.9	68.0	73.0	79.1	85.2	98.3	113.4	130.9	141.0	151.0	445
■ 0.79	0.81	0.90	0.92	0.94	0.97	0.97	1.00	1.01	1.03	1.05	1.08	1.11	1.13	1.15	1.16	446
...	38.0	43.7	49.3	55.7	62.1	75.7	91.2	109.1	119.2	129.3	446
...	38.2	43.9	49.4	55.9	62.3	75.9	91.4	109.2	119.4	129.5	447
...	31.5	37.1	42.5	53.1	58.2	63.4	69.6	75.7	89.0	104.1	121.8	131.9	141.9	448
...	21.0	34.7	42.6	47.8	52.9	63.1	68.2	73.2	79.3	85.4	98.5	113.6	131.2	141.2	151.2	449
...	...	30.7	38.8	44.0	49.2	59.5	64.6	69.7	75.8	81.9	95.1	110.2	127.8	137.8	147.9	450
■	0.76	0.88	0.90	0.93	0.96	0.94	0.97	0.99	1.01	1.03	1.07	1.10	1.13	1.14	1.15	450

▲ Not all available belt lengths are shown.

■ Combined Arc-Length correction factors for 5 preceding lines.



5VX & 5V BELTS IN 5V SHEAVES

LINE #	RATIO	STOCK SHEAVES			DRIVEN SPEEDS AND HORSEPOWER RATINGS PER BELT								
		Datum Diameter		Number Grooves	1160 RPM			1750 RPM			3500 RPM		
		DR	DN		Driven Speed	H.P. Ratings		Driven Speed	H.P. Ratings		Driven Speed	H.P. Ratings	
						5VX	5V		5VX	5V		5VX	5V
451	5.88	8.50	50.00	3-10	197	19.99	17.16	298	28.33	23.56
452	5.95	6.30	37.50	3-6	195	13.27	10.65	294	18.90	14.72	588	31.99	21.62
453	6.02	4.65	28.00	2-6	193	8.06	5.55	291	11.42	7.52	581	19.54	10.86
454	6.06	5.20	31.50	3-6	191	9.82	7.27	289	13.95	9.97	578	23.88	14.73
455	6.25	8.00	50.00	3-10	186	18.49	15.71	280	26.24	21.63
456	6.36	5.90	37.50	3-6	183	12.03	9.44	275	17.12	13.01	551	29.14	19.26
457	6.36	4.40	28.00	2-6	182	7.26	4.76	275	10.26	6.39	550	17.51	9.01
458	6.43	4.90	31.50	3-6	180	8.86	6.34	272	12.58	8.64	544	21.54	12.65
459	6.67	7.50	50.00	3-10	174	16.97	14.25	263	24.12	19.66
460	6.77	4.65	31.50	3-6	171	8.06	5.55	258	11.42	7.52	517	19.54	10.86
461	6.82	5.50	37.50	3-6	170	10.77	8.21	257	15.32	11.29	513	26.17	16.73
462	7.04	7.10	50.00	3-10	165	15.75	13.06	249	22.40	18.04	497	37.37	25.84
463	7.16	4.40	31.50	3-6	162	7.26	4.76	244	10.26	6.39	489	17.51	9.02
464	7.21	5.20	37.50	3-6	161	9.82	7.28	243	13.95	9.97	485	23.89	14.74
465	7.46	6.70	50.00	3-6	155	14.52	11.87	234	20.66	16.39	469	34.74	23.82
466	7.65	4.90	37.50	3-6	152	8.86	6.34	229	12.58	8.64	457	21.54	12.66
467	7.94	6.30	50.00	3-6	146	13.28	10.66	221	18.90	14.72	441	32.00	21.63
468	8.06	4.65	37.50	3-6	144	8.06	5.55	217	11.42	7.52	434	19.55	10.87
469	8.47	5.90	50.00	3-6	137	12.03	9.44	207	17.12	13.02	413	29.14	19.26
470	8.52	4.40	37.50	3-6	136	7.26	4.76	205	10.26	6.39	411	17.52	9.02
471	9.09	5.50	50.00	3-6	128	10.77	8.21	193	15.32	11.29	385	26.18	16.74
472	9.62	5.20	50.00	3-6	121	9.82	7.28	182	13.96	9.97	364	23.89	14.74
473	10.20	4.90	50.00	3-6	114	8.86	6.34	172	12.58	8.64	343	21.55	12.66
474	10.75	4.65	50.00	3-6	108	8.06	5.55	163	11.43	7.53	326	19.55	10.87
475	11.36	4.40	50.00	3-6	102	7.26	4.76	154	10.26	6.40	308	17.52	9.02

Shaded area diameters are below industry standard for belt.

DRIVE SELECTION TABLES



CENTER DISTANCE AND COMBINED ARC-LENGTH CORRECTION FACTOR ▲														LINE #
5VX 1250	5VX 1400	5VX 1500	5VX 1600	5VX 1800	5VX 1900	5VX 2000	5V 2120	5V 2240	5V 2500	5V 2800	5V 3150	5V 3350	5V 3550	
...	38.5	44.2	49.7	56.2	62.6	76.2	91.7	109.6	119.8	129.9	451
...	31.8	37.3	42.8	53.3	58.5	63.7	69.9	76.0	89.2	104.4	122.1	132.2	142.2	452
34.9	42.8	47.9	53.1	63.3	68.4	73.4	79.5	85.6	98.7	113.8	131.3	141.4	151.4	453
30.9	39.0	44.2	49.4	59.7	64.8	69.9	76.0	82.1	95.3	110.4	128.0	138.0	148.1	454
...	38.8	44.5	50.0	56.5	62.9	76.6	92.1	109.9	120.1	130.3	455
■	0.88	0.90	0.93	0.96	0.94	0.97	0.99	1.01	1.03	1.06	1.10	1.13	1.14	1.15 ■
...	32.0	37.6	43.0	53.6	58.8	64.0	70.1	76.3	89.5	104.7	122.4	132.5	142.5	456
35.1	42.9	48.1	53.2	63.5	68.5	73.6	79.7	85.7	98.8	113.9	131.5	141.6	151.6	457
31.1	39.2	44.4	49.6	59.9	65.1	70.2	76.3	82.3	95.5	110.6	128.2	138.3	148.3	458
...	39.1	44.8	50.4	56.9	63.3	76.9	92.4	110.3	120.5	130.6	459
31.2	39.3	44.6	49.8	60.1	65.2	70.3	76.4	82.5	95.7	110.8	128.4	138.5	148.5	460
■	0.87	0.90	0.93	0.96	0.97	0.99	1.01	1.03	1.04	1.07	1.10	1.13	1.15	1.16 ■
...	32.3	37.8	43.3	53.9	59.1	64.2	70.4	76.6	89.8	105.0	122.7	132.8	142.8	461
...	39.3	45.0	50.6	57.1	63.5	77.2	92.7	110.6	120.7	130.9	462
31.4	39.5	44.8	50.0	60.3	65.4	70.5	76.6	82.7	95.8	111.0	128.6	138.6	148.7	463
...	32.4	38.0	43.5	54.1	59.3	64.4	70.6	76.8	90.0	105.2	122.9	133.0	143.1	464
...	39.5	45.3	50.9	57.4	63.8	77.4	92.9	110.9	121.0	131.2	465
■	0.86	0.86	0.90	0.93	0.93	0.96	0.98	1.00	1.02	1.06	1.09	1.12	1.14	1.15 ■
...	32.6	38.2	43.7	54.3	59.5	64.6	70.8	77.0	90.2	105.4	123.1	133.2	143.3	466
...	39.8	45.5	51.1	57.6	64.1	77.7	93.2	111.1	121.3	131.5	467
23.7	32.8	38.4	43.8	54.4	59.6	64.8	71.0	77.1	90.4	105.6	123.3	133.4	143.5	468
...	40.0	45.8	51.4	57.9	64.3	78.0	93.5	111.4	121.6	131.8	469
23.8	32.9	38.5	44.0	54.6	59.8	65.0	71.2	77.3	90.6	105.8	123.5	133.6	143.6	470
■	0.70	0.84	0.89	0.92	0.92	0.95	0.98	1.00	1.02	1.06	1.09	1.12	1.13	1.15 ■
...	40.3	46.0	51.6	58.2	64.6	78.2	93.8	111.7	121.9	132.0	471
...	40.4	46.2	51.8	58.3	64.8	78.4	94.0	111.9	122.1	132.2	472
...	40.6	46.4	52.0	58.5	65.0	78.6	94.2	112.1	122.3	132.5	473
...	40.8	46.6	52.1	58.7	65.1	78.8	94.4	112.3	122.5	132.6	474
...	40.9	46.7	52.3	58.9	65.3	79.0	94.5	112.5	122.7	132.8	475
■					0.85	0.89	0.93	0.96	0.99	1.03	1.07	1.10	1.12	1.14 ■

- ▲ Not all available belt lengths are shown.
- Combined Arc-Length correction factors for 5 preceding lines.



8VX & 8V BELTS IN 8V SHEAVES

LINE #	RATIO	STOCK SHEAVES			DRIVEN SPEEDS AND HORSEPOWER RATINGS PER BELT					
		Datum Diameter		Number Grooves	870 MOTOR		1160 MOTOR		1750 MOTOR	
		DR	DN		Driven Speed	H.P. Ratings	Driven Speed	H.P. Ratings	Driven Speed	H.P. Ratings
1	1.00	12.50	12.50	4-6,8,10,12	870	36.11	1160	43.93	1750	52.44
2	1.00	13.20	13.20	4-6,8,10,12	870	39.97	1160	48.58	1750	57.56
3	1.00	14.00	14.00	4-6,8,10,12	870	44.32	1160	53.76	1750	62.97
4	1.00	15.00	15.00	4-6,8,10,12	870	49.64	1160	60.00
5	1.00	16.00	16.00	4-6,8,10,12	870	54.84	1160	65.99
6	1.00	17.00	17.00	4-6,8,10,12	870	59.91	1160	71.70
7	1.00	18.00	18.00	4-6,8,10,12	870	64.85	1160	77.12
8	1.00	19.00	19.00	4-6,8,10,12	870	69.65	1160	82.25
9	1.00	20.00	20.00	4-6,8,10,12	870	74.31	1160	87.06
10	1.00	21.20	21.20	4-6,8,10,12	870	79.71	1160	92.41
11	1.00	22.40	22.40	4-6,8,10,12	870	84.88
12	1.00	24.80	24.80	4-6,8,10,12	870	94.54
13	1.05	19.00	20.00	4-6,8,10,12	827	70.64	1102	83.57
14	1.06	18.00	19.00	4-6,8,10,12	824	65.89	1099	78.51
15	1.06	12.50	13.20	4-6,8,10,12	824	37.16	1098	45.32	1657	54.54
16	1.06	21.20	22.40	4-6,8,10,12	823	80.76	1098	93.82
17	1.06	17.00	18.00	4-6,8,10,12	822	61.00	1096	73.16
18	1.06	20.00	21.20	4-6,8,10,12	821	75.42	1094	88.54
19	1.06	13.20	14.00	4-6,8,10,12	820	41.09	1094	50.08	1650	59.81
20	1.06	16.00	17.00	4-6,8,10,12	819	55.99	1092	67.52
21	1.07	15.00	16.00	4-6,8,10,12	816	50.85	1088	61.63
22	1.07	14.00	15.00	4-6,8,10,12	812	45.60	1083	55.48	1633	65.56
23	1.11	22.40	24.80	4-6,8,10,12	786	86.66
24	1.11	18.00	20.00	4-6,8,10,12	783	66.67	1044	79.56
25	1.12	19.00	21.20	4-6,8,10,12	780	71.53	1040	84.76
26	1.12	17.00	19.00	4-6,8,10,12	778	61.82	1038	74.24
27	1.12	12.50	14.00	4-6,8,10,12	777	38.05	1036	46.51	1563	56.33
28	1.12	20.00	22.40	4-6,8,10,12	777	76.24	1036	89.64
29	1.13	16.00	18.00	4-6,8,10,12	773	56.83	1031	68.65
30	1.13	15.00	17.00	4-6,8,10,12	768	51.73	1024	62.79
31	1.14	13.20	15.00	4-6,8,10,12	766	42.09	1021	51.41	1540	61.83
32	1.14	14.00	16.00	4-6,8,10,12	761	46.51	1015	56.68	1531	67.37
33	1.17	21.20	24.80	4-6,8,10,12	744	82.16	992	95.68
34	1.18	17.00	20.00	4-6,8,10,12	739	62.43	986	75.06
35	1.18	18.00	21.20	4-6,8,10,12	739	67.38	985	80.50
36	1.18	19.00	22.40	4-6,8,10,12	738	72.19	984	85.64
37	1.19	16.00	19.00	4-6,8,10,12	733	57.45	977	69.48
38	1.20	12.50	15.00	4-6,8,10,12	725	38.83	967	47.55	1458	57.91
39	1.20	15.00	18.00	4-6,8,10,12	725	52.36	967	63.63
40	1.21	24.80	30.00	4-6,8,10,12	719	97.33
41	1.21	13.20	16.00	4-6,8,10,12	718	42.79	957	52.33	1444	63.22
42	1.21	14.00	17.00	4-6,8,10,12	716	47.15	955	57.53	1441	68.66
43	1.24	20.00	24.80	4-6,8,10,12	702	77.32	935	91.08
44	1.24	18.00	22.40	4-6,8,10,12	699	67.89	932	81.18
45	1.25	17.00	21.20	4-6,8,10,12	698	62.96	930	75.78
46	1.25	16.00	20.00	4-6,8,10,12	696	57.91	928	70.09
47	1.27	15.00	19.00	4-6,8,10,12	687	52.82	916	64.24
48	1.28	12.50	16.00	4-6,8,10,12	680	39.37	906	48.27	1367	58.99
49	1.29	14.00	18.00	4-6,8,10,12	677	47.60	902	58.14	1361	69.58
50	1.29	13.20	17.00	4-6,8,10,12	676	43.27	901	52.98	1359	64.19

DRIVE SELECTION TABLES



CENTER DISTANCE AND COMBINED ARC-LENGTH CORRECTION FACTOR ▲																LINE #
8VX 1060	8VX 1120	8VX 1180	8VX 1250	8VX 1320	8VX 1400	8VX 1500	8VX 1600	8VX 1700	8VX 1800	8VX 1900	8VX 2000	8V 2240	8V 2500	8V 2800	8V 3000	
33.4	36.4	39.4	42.9	46.4	50.4	55.4	60.4	65.4	70.4	75.4	80.4	92.4	105.4	120.4	130.4	1
32.3	35.3	38.3	41.8	45.3	49.3	54.3	59.3	64.3	69.3	74.3	79.3	91.3	104.3	119.3	129.3	2
31.0	34.0	37.0	40.5	44.0	48.0	53.0	58.0	63.0	68.0	73.0	78.0	90.0	103.0	118.0	128.0	3
29.4	32.4	35.4	38.9	42.4	46.4	51.4	56.4	61.4	66.4	71.4	76.4	88.4	101.4	116.4	126.4	4
27.9	30.9	33.9	37.4	40.9	44.9	49.9	54.9	59.9	64.9	69.9	74.9	86.9	99.9	114.9	124.9	5
■ 0.86	0.87	0.88	0.89	0.90	0.91	0.92	0.93	0.94	0.95	0.96	0.96	0.98	1.00	1.02	1.03	■
26.3	29.3	32.3	35.8	39.3	43.3	48.3	53.3	58.3	63.3	68.3	73.3	85.3	98.3	113.3	123.3	6
24.7	27.7	30.7	34.2	37.7	41.7	46.7	51.7	56.7	61.7	66.7	71.7	83.7	96.7	111.7	121.7	7
23.2	26.2	29.2	32.7	36.2	40.2	45.2	50.2	55.2	60.2	65.2	70.2	82.2	95.2	110.2	120.2	8
...	24.6	27.6	31.1	34.6	38.6	43.6	48.6	53.6	58.6	63.6	68.6	80.6	93.6	108.6	118.6	9
...	...	25.7	29.2	32.7	36.7	41.7	46.7	51.7	56.7	61.7	66.7	78.7	91.7	106.7	116.7	10
■ 0.86	0.87	0.88	0.89	0.90	0.91	0.92	0.93	0.94	0.95	0.96	0.96	0.98	1.00	1.02	1.03	■
...	27.3	30.8	34.8	39.8	44.8	49.8	54.8	59.8	64.8	76.8	89.8	104.8	114.8	11
...	31.0	36.0	41.0	46.0	51.0	56.0	61.0	73.0	86.0	101.0	111.0	12
...	25.4	28.4	31.9	35.4	39.4	44.4	49.4	54.4	59.4	64.4	69.4	81.4	94.4	109.4	119.4	13
23.9	26.9	29.9	33.4	36.9	40.9	45.9	50.9	55.9	60.9	65.9	70.9	82.9	95.9	110.9	120.9	14
32.8	35.8	38.8	42.3	45.8	49.8	54.8	59.8	64.8	69.8	74.8	79.8	91.8	104.8	119.8	129.8	15
■ 0.86	0.86	0.87	0.88	0.89	0.90	0.92	0.93	0.94	0.95	0.95	0.96	0.98	1.00	1.02	1.03	■
...	28.3	31.8	35.8	40.8	45.8	50.8	55.8	60.8	65.8	77.8	90.8	105.8	115.8	16
25.5	28.5	31.5	35.0	38.5	42.5	47.5	52.5	57.5	62.5	67.5	72.5	84.5	97.5	112.5	122.5	17
...	...	26.6	30.1	33.6	37.6	42.6	47.6	52.6	57.6	62.6	67.6	79.6	92.6	107.6	117.6	18
31.6	34.6	37.6	41.1	44.6	48.6	53.6	58.6	63.6	68.6	73.6	78.6	90.6	103.6	118.6	128.6	19
27.1	30.1	33.1	36.6	40.1	44.1	49.1	54.1	59.1	64.1	69.1	74.1	86.1	99.1	114.1	124.1	20
■ 0.86	0.87	0.87	0.88	0.89	0.90	0.91	0.92	0.93	0.94	0.95	0.96	0.98	1.00	1.02	1.03	■
28.6	31.6	34.6	38.1	41.6	45.6	50.6	55.6	60.6	65.6	70.6	75.6	87.6	100.6	115.6	125.6	21
30.2	33.2	36.2	39.7	43.2	47.2	52.2	57.2	62.2	67.2	72.2	77.2	89.2	102.2	117.2	127.2	22
...	28.9	32.9	37.9	42.9	47.9	52.9	57.9	62.9	74.9	87.9	102.9	112.9	23
23.1	26.1	29.1	32.6	36.1	40.1	45.1	50.1	55.1	60.1	65.1	70.1	82.1	95.1	110.1	120.1	24
...	24.4	27.4	30.9	34.4	38.4	43.4	48.4	53.4	58.4	63.4	68.4	80.4	93.4	108.4	118.4	25
■ 0.85	0.86	0.87	0.88	0.89	0.90	0.91	0.92	0.93	0.94	0.95	0.96	0.98	1.00	1.02	1.03	■
24.7	27.7	30.7	34.2	37.7	41.7	46.7	51.7	56.7	61.7	66.7	71.7	83.7	96.7	111.7	121.7	26
32.2	35.2	38.2	41.7	45.2	49.2	54.2	59.2	64.2	69.2	74.2	79.2	91.2	104.2	119.2	129.2	27
...	...	25.7	29.2	32.7	36.7	41.7	46.7	51.7	56.7	61.7	66.7	78.7	91.7	106.7	116.7	28
26.3	29.3	32.3	35.8	39.3	43.3	48.3	53.3	58.3	63.3	68.3	73.3	85.3	98.3	113.3	123.3	29
27.8	30.9	33.9	37.4	40.9	44.9	49.9	54.9	59.9	64.9	69.9	74.9	86.9	99.9	114.9	124.9	30
■ 0.85	0.86	0.87	0.88	0.89	0.90	0.91	0.92	0.93	0.94	0.95	0.96	0.98	1.00	1.02	1.03	■
30.8	33.8	36.8	40.3	43.8	47.8	52.8	57.8	62.8	67.8	72.8	77.8	89.8	102.8	117.8	127.8	31
29.4	32.4	35.4	38.9	42.4	46.4	51.4	56.4	61.4	66.4	71.4	76.4	88.4	101.4	116.4	126.4	32
...	29.8	33.8	38.8	43.8	48.8	53.8	58.8	63.8	75.9	88.9	103.9	113.9	33
23.9	26.9	29.9	33.4	36.9	40.9	45.9	50.9	55.9	60.9	65.9	70.9	82.9	95.9	110.9	120.9	34
...	25.2	28.2	31.7	35.2	39.2	44.2	49.2	54.2	59.2	64.2	69.2	81.2	94.2	109.2	119.2	35
■ 0.85	0.86	0.87	0.88	0.89	0.90	0.91	0.92	0.93	0.94	0.95	0.96	0.98	1.00	1.02	1.03	■
...	...	26.4	29.9	33.4	37.4	42.5	47.5	52.5	57.5	62.5	67.5	79.5	92.5	107.5	117.5	36
25.5	28.5	31.5	35.0	38.5	42.5	47.5	52.5	57.5	62.5	67.5	72.5	84.5	97.5	112.5	122.5	37
31.4	34.4	37.4	40.9	44.4	48.4	53.4	58.4	63.4	68.4	73.4	78.4	90.4	103.4	118.4	128.4	38
27.0	30.0	33.0	36.6	40.1	44.1	49.1	54.1	59.1	64.1	69.1	74.1	86.1	99.1	114.1	124.1	39
...	31.9	36.9	41.9	46.9	51.9	56.9	68.9	81.9	96.9	106.9	40
■ 0.85	0.86	0.87	0.88	0.89	0.90	0.91	0.92	0.93	0.94	0.95	0.96	0.98	1.00	1.01	1.03	■
30.0	33.0	36.0	39.5	43.0	47.0	52.0	57.0	62.0	67.0	72.0	77.0	89.0	102.0	117.0	127.0	41
28.6	31.6	34.6	38.1	41.6	45.6	50.6	55.6	60.6	65.6	70.6	75.6	87.6	100.6	115.6	125.6	42
...	27.2	30.7	34.7	39.7	44.7	49.7	54.7	59.7	64.7	76.7	89.7	104.7	114.7	43
...	24.2	27.2	30.7	34.2	38.2	43.2	48.2	53.2	58.2	63.2	68.2	80.2	93.2	108.2	118.2	44
22.9	25.9	28.9	32.4	35.9	39.9	44.9	50.0	55.0	60.0	65.0	70.0	82.0	95.0	110.0	120.0	45
■ 0.84	0.85	0.86	0.87	0.88	0.89	0.91	0.92	0.93	0.94	0.95	0.96	0.98	0.99	1.01	1.03	■
24.6	27.7	30.7	34.2	37.7	41.7	46.7	51.7	56.7	61.7	66.7	71.7	83.7	96.7	111.7	121.7	46
26.2	29.2	32.2	35.7	39.2	43.3	48.3	53.3	58.3	63.3	68.3	73.3	85.3	98.3	113.3	123.3	47
30.6	33.6	36.6	40.1	43.6	47.6	52.6	57.6	62.6	67.6	72.6	77.6	89.6	102.6	117.6	127.6	48
27.8	30.8	33.8	37.3	40.8	44.8	49.8	54.8	59.8	64.8	69.8	74.8	86.8	99.8	114.8	124.9	49
29.2	32.2	35.2	38.7	42.2	46.2	51.2	56.2	61.3	66.3	71.3	76.3	88.3	101.3	116.3	126.3	50
■ 0.84	0.85	0.86	0.87	0.88	0.89	0.91	0.92	0.93	0.94	0.95	0.96	0.98	1.00	1.01	1.03	■

▲ Not all available belt lengths are shown.

■ Combined Arc-Length correction factors for 5 preceding lines.



8VX & 8V BELTS IN 8V SHEAVES

LINE #	RATIO	STOCK SHEAVES			DRIVEN SPEEDS AND HORSEPOWER RATINGS PER BELT					
		Datum Diameter		Number Grooves	870 MOTOR		1160 MOTOR		1750 MOTOR	
		DR	DN		Driven Speed	H.P. Ratings	Driven Speed	H.P. Ratings	Driven Speed	H.P. Ratings
51	1.31	19.00	24.80	4-6,8,10,12	667	73.04	889	86.77
52	1.32	17.00	22.40	4-6,8,10,12	660	63.36	880	76.30
53	1.33	16.00	21.20	4-6,8,10,12	657	58.32	875	70.63
54	1.33	15.00	20.00	4-6,8,10,12	653	53.16	870	64.70
55	1.34	22.40	30.00	4-6,8,10,12	650	88.43
56	1.36	14.00	19.00	4-6,8,10,12	641	47.94	855	58.59	1289	70.25
57	1.36	12.50	17.00	4-6,8,10,12	640	39.74	853	48.77	1287	59.74
58	1.36	13.20	18.00	4-6,8,10,12	638	43.62	851	53.44	1283	64.89
59	1.38	18.00	24.80	4-6,8,10,12	631	68.55	842	82.06
60	1.40	16.00	22.40	4-6,8,10,12	621	58.61	829	71.02
61	1.41	15.00	21.20	4-6,8,10,12	616	53.46	821	65.10
62	1.42	21.20	30.00	4-6,8,10,12	615	83.53	820	97.51
63	1.43	14.00	20.00	4-6,8,10,12	609	48.18	812	58.92	1225	70.75
64	1.43	24.80	35.50	4-6,8,10,12	608	98.41
65	1.44	13.20	19.00	4-6,8,10,12	604	43.87	806	53.78	1216	65.40
66	1.44	12.50	18.00	4-6,8,10,12	604	40.01	806	49.13	1215	60.28
67	1.46	17.00	24.80	4-6,8,10,12	596	63.86	795	76.97
68	1.49	15.00	22.40	4-6,8,10,12	583	53.68	777	65.39
69	1.50	20.00	30.00	4-6,8,10,12	580	78.36	773	92.47
70	1.51	14.00	21.20	4-6,8,10,12	575	48.40	766	59.21	1156	71.19
71	1.52	13.20	20.00	4-6,8,10,12	574	44.06	766	54.03	1155	65.78
72	1.52	12.50	19.00	4-6,8,10,12	572	40.21	763	49.39	1151	60.68
73	1.55	16.00	24.80	4-6,8,10,12	561	58.99	748	71.53
74	1.58	19.00	30.00	4-6,8,10,12	551	73.86	735	87.86
75	1.58	22.40	35.50	4-6,8,10,12	549	89.10
76	1.60	12.50	20.00	4-6,8,10,12	544	40.36	725	49.59	1094	60.98
77	1.60	14.00	22.40	4-6,8,10,12	544	48.56	725	59.42	1094	71.51
78	1.61	13.20	21.20	4-6,8,10,12	542	44.23	722	54.26	1090	66.12
79	1.61	24.80	40.00	4-6,8,10,12	539	98.81
80	1.65	15.00	24.80	4-6,8,10,12	526	53.96	702	65.77
81	1.67	18.00	30.00	4-6,8,10,12	522	69.19	696	82.91
82	1.67	21.20	35.50	4-6,8,10,12	520	84.06	693	98.21
83	1.70	12.50	21.20	4-6,8,10,12	513	40.49	684	49.77	1032	61.24
84	1.70	13.20	22.40	4-6,8,10,12	513	44.35	684	54.42	1031	66.37
85	1.76	17.00	30.00	4-6,8,10,12	493	64.36	657	77.63
86	1.77	14.00	24.80	4-6,8,10,12	491	48.77	655	59.70	988	71.93
87	1.77	20.00	35.50	4-6,8,10,12	490	78.77	654	93.01
88	1.79	22.40	40.00	4-6,8,10,12	487	89.35
89	1.79	12.50	22.40	4-6,8,10,12	485	40.59	647	49.90	977	61.44
90	1.79	24.80	44.50	4-6,8,10,12	485	99.02
91	1.87	19.00	35.50	4-6,8,10,12	466	74.19	621	88.30
92	1.88	16.00	30.00	4-6,8,10,12	464	59.38	619	72.04
93	1.88	13.20	24.80	4-6,8,10,12	463	44.52	617	54.64	931	66.70
94	1.89	21.20	40.00	4-6,8,10,12	461	84.26	615	98.47
95	1.97	18.00	35.50	4-6,8,10,12	441	69.45	588	83.26
96	1.98	12.50	24.80	4-6,8,10,12	439	40.72	585	50.07	882	61.71
97	1.99	22.40	44.50	4-6,8,10,12	438	89.49
98	2.00	15.00	30.00	4-6,8,10,12	435	54.26	580	66.16
99	2.00	20.00	40.00	4-6,8,10,12	435	78.93	580	93.22
100	2.09	17.00	35.50	4-6,8,10,12	417	64.57	555	77.91

DRIVE SELECTION TABLES



CENTER DISTANCE AND COMBINED ARC-LENGTH CORRECTION FACTOR ▲																LINE #
8VX 1120	8VX 1180	8VX 1250	8VX 1320	8VX 1400	8VX 1500	8VX 1600	8VX 1700	8VX 1800	8VX 1900	8VX 2000	8V 2240	8V 2500	8V 2800	8V 3000	8V 3150	
...	...	27.9	31.5	35.5	40.5	45.5	50.5	55.5	60.5	65.5	77.5	90.6	105.6	115.6	123.1	51
24.9	27.9	31.4	35.0	39.0	44.0	49.0	54.0	59.0	64.0	69.0	81.0	94.0	109.0	119.0	126.5	52
26.7	29.7	33.2	36.7	40.7	45.7	50.7	55.7	60.7	65.7	70.7	82.7	95.7	110.8	120.8	128.3	53
28.4	31.4	34.9	38.4	42.4	47.4	52.5	57.5	62.5	67.5	72.5	84.5	97.5	112.5	122.5	130.0	54
...	33.6	38.7	43.7	48.7	53.7	58.7	70.7	83.8	98.8	108.8	116.3	55
■ 0.85	■ 0.86	■ 0.87	■ 0.88	■ 0.89	■ 0.90	■ 0.91	■ 0.92	■ 0.93	■ 0.94	■ 0.95	■ 0.97	■ 0.99	■ 1.01	■ 1.02	■ 1.03	■
30.0	33.0	36.5	40.0	44.0	49.0	54.0	59.0	64.0	69.0	74.0	86.0	99.1	114.1	124.1	131.6	56
32.8	35.8	39.3	42.8	46.8	51.8	56.8	61.8	66.8	71.8	76.8	88.8	101.8	116.8	126.8	134.3	57
31.4	34.4	37.9	41.4	45.4	50.4	55.4	60.4	65.5	70.5	75.5	87.5	100.5	115.5	125.5	133.0	58
...	25.2	28.7	32.2	36.2	41.2	46.3	51.3	56.3	61.3	66.3	78.3	91.3	106.3	116.3	123.8	59
25.6	28.7	32.2	35.7	39.7	44.7	49.7	54.7	59.8	64.8	69.8	81.8	94.8	109.8	119.8	127.3	60
■ 0.85	■ 0.86	■ 0.87	■ 0.88	■ 0.89	■ 0.90	■ 0.91	■ 0.92	■ 0.94	■ 0.94	■ 0.95	■ 0.97	■ 0.99	■ 1.01	■ 1.02	■ 1.03	■
27.4	30.4	33.9	37.4	41.5	46.5	51.5	56.5	61.5	66.5	71.5	83.5	96.5	111.5	121.5	129.0	61
...	29.5	34.5	39.5	44.6	49.6	54.6	59.6	71.7	84.7	99.7	109.7	117.2	62
29.1	32.2	35.7	39.2	43.2	48.2	53.2	58.2	63.2	68.2	73.2	85.2	98.3	113.3	123.3	130.8	63
...	37.3	42.3	47.3	52.4	64.4	77.5	92.5	102.5	110.0	64
30.6	33.6	37.1	40.6	44.6	49.6	54.6	59.6	64.6	69.6	74.7	86.7	99.7	114.7	124.7	132.2	65
■ 0.84	■ 0.85	■ 0.87	■ 0.88	■ 0.88	■ 0.90	■ 0.91	■ 0.92	■ 0.93	■ 0.94	■ 0.95	■ 0.97	■ 0.99	■ 1.01	■ 1.02	■ 1.03	■
31.9	34.9	38.4	42.0	46.0	51.0	56.0	61.0	66.0	71.0	76.0	88.0	101.0	116.0	126.0	133.5	66
...	25.9	29.4	32.9	37.0	42.0	47.0	52.0	57.0	62.0	67.1	79.1	92.1	107.1	117.1	124.6	67
26.4	29.4	32.9	36.4	40.5	45.5	50.5	55.5	60.5	65.5	70.5	82.5	95.6	110.6	120.6	128.1	68
...	30.3	35.4	40.4	45.5	50.5	55.5	60.5	72.6	85.6	100.6	110.6	118.1	69
28.1	31.1	34.7	38.2	42.2	47.2	52.2	57.2	62.2	67.3	72.3	84.3	97.3	112.3	122.3	129.8	70
■ 0.84	■ 0.85	■ 0.86	■ 0.87	■ 0.88	■ 0.89	■ 0.91	■ 0.92	■ 0.93	■ 0.94	■ 0.95	■ 0.97	■ 0.99	■ 1.01	■ 1.02	■ 1.03	■
29.7	32.7	36.3	39.8	43.8	48.8	53.8	58.8	63.8	68.8	73.8	85.9	98.9	113.9	123.9	131.4	71
31.1	34.1	37.6	41.1	45.1	50.2	55.2	60.2	65.2	70.2	75.2	87.2	100.2	115.2	125.2	132.7	72
...	26.6	30.1	33.7	37.7	42.7	47.8	52.8	57.8	62.8	67.8	79.8	92.9	107.9	117.9	125.4	73
...	31.0	36.1	41.1	46.2	51.2	56.2	61.3	73.3	86.3	101.4	111.4	118.9	74
...	33.9	39.0	44.0	49.1	54.1	66.2	79.3	94.3	104.3	111.8	75
■ 0.84	■ 0.85	■ 0.86	■ 0.87	■ 0.88	■ 0.89	■ 0.90	■ 0.91	■ 0.92	■ 0.93	■ 0.94	■ 0.97	■ 0.99	■ 1.01	■ 1.02	■ 1.03	■
30.2	33.3	36.8	40.3	44.3	49.3	54.3	59.4	64.4	69.4	74.4	86.4	99.4	114.4	124.4	131.9	76
27.1	30.1	33.6	37.2	41.2	46.2	51.2	56.3	61.3	66.3	71.3	83.3	96.3	111.3	121.3	128.8	77
28.7	31.7	35.3	38.8	42.8	47.8	52.8	57.8	62.9	67.9	72.9	84.9	97.9	112.9	122.9	130.4	78
...	38.4	43.4	48.5	60.6	73.7	88.8	98.8	106.3	79
24.2	27.3	30.9	34.4	38.4	43.5	48.5	53.5	58.5	63.6	68.6	80.6	93.6	108.6	118.6	126.1	80
■ 0.83	■ 0.84	■ 0.86	■ 0.87	■ 0.88	■ 0.89	■ 0.91	■ 0.92	■ 0.92	■ 0.93	■ 0.94	■ 0.96	■ 0.99	■ 1.01	■ 1.02	■ 1.03	■
...	27.6	31.7	36.8	41.9	46.9	52.0	57.0	62.0	74.1	87.1	102.1	112.1	119.7	81
...	34.7	39.8	44.9	50.0	55.0	67.1	80.1	95.2	105.2	112.7	82
29.2	32.2	35.8	39.3	43.3	48.3	53.4	58.4	63.4	68.4	73.4	85.4	98.4	113.4	123.5	131.0	83
27.7	30.7	34.2	37.8	41.8	46.8	51.8	56.9	61.9	66.9	71.9	83.9	96.9	111.9	122.0	129.5	84
...	28.3	32.4	37.5	42.6	47.6	52.7	57.7	62.7	74.8	87.8	102.9	112.9	120.4	85
■ 0.83	■ 0.84	■ 0.86	■ 0.85	■ 0.87	■ 0.88	■ 0.89	■ 0.91	■ 0.92	■ 0.93	■ 0.94	■ 0.96	■ 0.98	■ 1.00	■ 1.02	■ 1.03	■
24.9	28.0	31.6	35.1	39.2	44.2	49.2	54.3	59.3	64.3	69.3	81.3	94.4	109.4	119.4	126.9	86
...	35.6	40.7	45.8	50.8	55.9	68.0	81.0	96.1	106.1	113.6	87
...	34.9	40.0	45.1	50.2	62.4	75.5	90.6	100.6	108.1	88
28.2	31.2	34.7	38.3	42.3	47.3	52.4	57.4	62.4	67.4	72.4	84.4	97.5	112.5	122.5	130.0	89
...	39.3	44.5	56.7	69.9	85.0	95.1	102.6	90
■ 0.82	■ 0.83	■ 0.85	■ 0.86	■ 0.87	■ 0.89	■ 0.89	■ 0.90	■ 0.91	■ 0.91	■ 0.93	■ 0.95	■ 0.98	■ 1.00	■ 1.01	■ 1.02	■
...	31.1	36.3	41.4	46.5	51.5	56.6	68.7	81.8	96.8	106.9	114.4	91
...	29.0	33.1	38.2	43.3	48.4	53.4	58.5	63.5	75.5	88.6	103.6	113.7	121.2	92
25.5	28.6	32.1	35.7	39.7	44.8	49.8	54.8	59.9	64.9	69.9	81.9	95.0	110.0	120.0	127.5	93
...	35.7	40.9	46.0	51.1	63.2	76.4	91.5	101.5	109.0	94
...	31.8	36.9	42.1	47.2	52.2	57.3	69.4	82.5	97.6	107.6	115.1	95
■ 0.81	■ 0.83	■ 0.84	■ 0.84	■ 0.86	■ 0.86	■ 0.88	■ 0.89	■ 0.90	■ 0.92	■ 0.93	■ 0.95	■ 0.97	■ 1.00	■ 1.01	■ 1.02	■
26.0	29.1	32.6	36.2	40.2	45.3	50.3	55.4	60.4	65.4	70.4	82.5	95.5	110.5	120.5	128.1	96
...	41.0	46.1	58.4	71.6	86.8	96.8	104.4	97
...	...	26.1	29.7	33.8	38.9	44.0	49.1	54.1	59.2	64.2	76.3	89.3	104.4	114.4	121.9	98
...	36.5	41.7	46.8	51.9	64.1	77.2	92.3	102.4	109.9	99
...	32.4	37.6	42.8	47.9	53.0	58.0	70.2	83.3	98.3	108.4	115.9	100
■ 0.81	■ 0.82	■ 0.82	■ 0.84	■ 0.86	■ 0.86	■ 0.88	■ 0.89	■ 0.90	■ 0.91	■ 0.92	■ 0.95	■ 0.97	■ 0.99	■ 1.01	■ 1.02	■

▲ Not all available belt lengths are shown.

■ Combined Arc-Length correction factors for 5 preceding lines.



8VX & 8V BELTS IN 8V SHEAVES

LINE #	RATIO	STOCK SHEAVES			DRIVEN SPEEDS AND HORSEPOWER RATINGS PER BELT					
		Datum Diameter		Number Grooves	870 MOTOR		1160 MOTOR		1750 MOTOR	
		DR	DN		Driven Speed	H.P. Ratings	Driven Speed	H.P. Ratings	Driven Speed	H.P. Ratings
101	2.10	21.20	44.50	4-6,8,10,12	414	84.37	553	98.62
102	2.11	19.00	40.00	4-6,8,10,12	413	74.31	551	88.47
103	2.14	24.80	53.00	4-6,8,10,12	407	99.22
104	2.14	14.00	30.00	4-6,8,10,12	406	49.00	541	60.00	817	72.38
105	2.22	16.00	35.50	4-6,8,10,12	392	59.54	523	72.26
106	2.22	18.00	40.00	4-6,8,10,12	391	69.55	522	83.40
107	2.22	20.00	44.50	4-6,8,10,12	391	79.02	521	93.34
108	2.27	13.20	30.00	4-6,8,10,12	383	44.69	510	54.88	770	67.06
109	2.34	19.00	44.50	4-6,8,10,12	371	74.39	495	88.57
110	2.35	17.00	40.00	4-6,8,10,12	370	64.65	493	78.02
111	2.37	22.40	53.00	4-6,8,10,12	368	89.63
112	2.37	15.00	35.50	4-6,8,10,12	368	54.38	490	66.33
113	2.40	12.50	30.00	4-6,8,10,12	363	40.87	483	50.27	729	62.00
114	2.47	18.00	44.50	4-6,8,10,12	352	69.61	469	83.48
115	2.50	16.00	40.00	4-6,8,10,12	348	59.61	464	72.35
116	2.50	21.20	53.00	4-6,8,10,12	348	84.48	464	98.77
117	2.54	14.00	35.50	4-6,8,10,12	343	49.10	457	60.13	690	72.58
118	2.54	24.80	63.00	6,8,10,12	342	99.32
119	2.62	17.00	44.50	4-6,8,10,12	332	64.70	443	78.09
120	2.65	20.00	53.00	4-6,8,10,12	328	79.11	438	93.46
121	2.67	15.00	40.00	4-6,8,10,12	326	54.44	435	66.40
122	2.69	13.20	35.50	4-6,8,10,12	323	44.78	431	54.99	651	67.22
123	2.78	16.00	44.50	4-6,8,10,12	313	59.65	417	72.41
124	2.79	19.00	53.00	4-6,8,10,12	312	74.46	416	88.67
125	2.81	22.40	63.00	6,8,10,12	309	89.70
126	2.84	12.50	35.50	4-6,8,10,12	306	40.93	408	50.36	616	62.14
127	2.86	14.00	40.00	4-6,8,10,12	305	49.14	406	60.19	613	72.67
128	2.86	24.80	71.00	6,8,10,12	304	99.36
129	2.94	18.00	53.00	4-6,8,10,12	295	69.68	394	83.57
130	2.97	15.00	44.50	4-6,8,10,12	293	54.47	391	66.45
131	2.97	21.20	63.00	6,8,10,12	293	84.54	390	98.85
132	3.03	13.20	40.00	4-6,8,10,12	287	44.81	383	55.04	578	67.29
133	3.12	17.00	53.00	4-6,8,10,12	279	64.75	372	78.16
134	3.15	20.00	63.00	6,8,10,12	276	79.16	368	93.53
135	3.17	22.40	71.00	6,8,10,12	274	89.73
136	3.18	14.00	44.50	4-6,8,10,12	274	49.17	365	60.23	551	72.72
137	3.20	12.50	40.00	4-6,8,10,12	272	40.96	363	50.40	547	62.20
138	3.31	16.00	53.00	4-6,8,10,12	263	59.70	350	72.47
139	3.32	19.00	63.00	6,8,10,12	262	74.51	350	88.73
140	3.35	21.20	71.00	6,8,10,12	260	84.57	346	98.89
141	3.37	13.20	44.50	4-6,8,10,12	258	44.84	344	55.07	519	67.34
142	3.50	18.00	63.00	6,8,10,12	249	69.72	331	83.62
143	3.53	15.00	53.00	4-6,8,10,12	246	54.51	328	66.50
144	3.55	20.00	71.00	6,8,10,12	245	79.18	327	93.56
145	3.56	12.50	44.50	4-6,8,10,12	244	40.98	326	50.42	492	62.24
146	3.71	17.00	63.00	6,8,10,12	235	64.79	313	78.20
147	3.74	19.00	71.00	6,8,10,12	233	74.53	310	88.75
148	3.79	14.00	53.00	4-6,8,10,12	230	49.20	306	60.27	462	72.79
149	3.94	16.00	63.00	6,8,10,12	221	59.72	295	72.50
150	3.94	18.00	71.00	6,8,10,12	221	69.73	294	83.64

DRIVE SELECTION TABLES



CENTER DISTANCE AND COMBINED ARC-LENGTH CORRECTION FACTOR ▲															LINE #
8VX 1500	8VX 1600	8VX 1700	8VX 1800	8VX 1900	8VX 2000	8V 2240	8V 2500	8V 2800	8V 3000	8V 3150	8V 3550	8V 4000	8V 4500	8V 5000	
...	36.5	41.8	47.0	59.3	72.5	87.6	97.7	105.3	125.4	147.9	173.0	198.1	101
...	...	37.2	42.4	47.5	52.6	64.8	78.0	93.1	103.1	110.7	130.7	153.3	178.4	203.4	102
...	48.9	62.3	77.6	87.8	95.4	115.5	138.2	163.3	188.4	103
39.6	44.7	49.8	54.9	59.9	64.9	77.0	90.1	105.1	115.2	122.7	142.7	165.2	190.3	215.3	104
33.1	38.3	43.5	48.6	53.7	58.7	70.9	84.0	99.1	109.1	116.6	136.7	159.3	184.3	209.3	105
■ 0.85	■ 0.87	■ 0.88	■ 0.88	■ 0.90	■ 0.91	■ 0.93	■ 0.96	■ 0.98	■ 1.00	■ 1.01	■ 1.03	■ 1.06	■ 1.08	■ 1.10	■
...	32.6	37.8	43.0	48.2	53.3	65.5	78.7	93.8	103.9	111.4	131.5	154.1	179.1	204.2	106
...	37.3	42.6	47.8	60.1	73.3	88.5	98.6	106.1	126.2	148.8	173.9	199.0	107
40.2	45.3	50.4	55.4	60.5	65.5	77.6	90.7	105.7	115.8	123.3	143.3	165.9	190.9	215.9	108
...	38.0	43.2	48.4	60.8	74.0	89.2	99.3	106.9	127.0	149.6	174.7	199.7	109
...	33.2	38.5	43.7	48.9	54.0	66.2	79.4	94.5	104.6	112.1	132.2	154.8	179.9	204.9	110
■ 0.86	■ 0.84	■ 0.87	■ 0.87	■ 0.89	■ 0.90	■ 0.93	■ 0.96	■ 0.99	■ 1.00	■ 1.01	■ 1.03	■ 1.06	■ 1.08	■ 1.10	■
...	50.5	64.0	79.3	89.5	97.1	117.3	139.9	165.1	190.2	111
33.8	39.0	44.1	49.3	54.4	59.5	71.6	84.7	99.8	109.9	117.4	137.5	160.0	185.1	210.1	112
40.7	45.8	50.9	55.9	61.0	66.0	78.1	91.2	106.3	116.3	123.8	143.9	166.4	191.4	216.4	113
...	38.6	43.9	49.1	61.5	74.7	89.9	100.0	107.6	127.7	150.3	175.4	200.5	114
...	33.9	39.2	44.4	49.6	54.7	66.9	80.1	95.3	105.3	112.9	133.0	155.6	180.6	205.7	115
■ 0.85	■ 0.85	■ 0.87	■ 0.88	■ 0.89	■ 0.91	■ 0.93	■ 0.96	■ 0.98	■ 1.00	■ 1.01	■ 1.03	■ 1.05	■ 1.08	■ 1.10	■
...	51.3	64.8	80.1	90.3	97.9	118.2	140.8	166.0	191.1	116
34.4	39.7	44.8	50.0	55.1	60.2	72.3	85.4	100.5	110.6	118.1	138.2	160.8	185.8	210.8	117
...	52.6	68.4	78.7	86.4	106.8	129.6	154.9	180.0	118
...	39.3	44.6	49.8	62.2	75.4	90.7	100.8	108.3	128.5	151.1	176.2	201.2	119
...	52.1	65.6	81.0	91.2	98.8	119.0	141.7	166.8	192.0	120
■ 0.83	■ 0.85	■ 0.87	■ 0.86	■ 0.88	■ 0.90	■ 0.91	■ 0.93	■ 0.96	■ 0.98	■ 0.99	■ 1.02	■ 1.05	■ 1.07	■ 1.09	■
...	34.5	39.8	45.1	50.2	55.4	67.6	80.8	96.0	106.1	113.6	133.7	156.3	181.4	206.4	121
35.0	40.2	45.4	50.5	55.6	60.7	72.9	86.0	101.1	111.2	118.7	138.8	161.4	186.4	211.5	122
...	...	34.5	39.9	45.2	50.5	62.9	76.1	91.4	101.5	109.1	129.2	151.8	176.9	202.0	123
...	39.8	52.7	66.3	81.7	91.9	99.5	119.7	142.4	167.6	192.7	124
...	54.1	70.0	80.4	88.1	108.5	131.4	156.6	181.8	125
■ 0.83	■ 0.83	■ 0.84	■ 0.86	■ 0.88	■ 0.88	■ 0.92	■ 0.93	■ 0.97	■ 0.98	■ 1.00	■ 1.02	■ 1.05	■ 1.07	■ 1.09	■
35.4	40.7	45.9	51.0	56.1	61.2	73.4	86.5	101.7	111.7	119.2	139.3	161.9	186.9	212.0	126
...	35.2	40.5	45.7	50.9	56.1	68.4	81.6	96.7	106.8	114.3	134.5	157.1	182.1	207.2	127
...	60.3	71.0	78.9	99.6	122.6	148.0	173.2	128
...	40.5	53.4	66.9	82.4	92.6	100.2	120.5	143.2	168.3	193.4	129
...	...	35.2	40.6	45.9	51.1	63.6	76.9	92.1	102.2	109.8	129.9	152.6	177.7	202.7	130
■ 0.82	■ 0.83	■ 0.84	■ 0.86	■ 0.88	■ 0.88	■ 0.92	■ 0.95	■ 0.96	■ 0.98	■ 0.99	■ 1.02	■ 1.04	■ 1.07	■ 1.09	■
...	54.9	70.8	81.2	88.9	109.4	132.2	157.5	182.7	131
30.2	35.7	41.0	46.3	51.5	56.6	68.9	82.1	97.3	107.4	114.9	135.1	157.6	182.7	207.8	132
...	41.1	54.0	67.6	83.1	93.3	100.9	121.2	143.9	169.1	194.2	133
...	55.7	71.6	82.0	89.7	110.2	133.1	158.4	183.6	134
...	61.9	72.6	80.5	101.2	124.3	149.7	175.0	135
■ 0.78	■ 0.82	■ 0.84	■ 0.86	■ 0.88	■ 0.86	■ 0.90	■ 0.91	■ 0.94	■ 0.96	■ 0.97	■ 1.01	■ 1.03	■ 1.06	■ 1.08	■
...	...	35.8	41.2	46.6	51.8	64.2	77.6	92.8	102.9	110.5	130.7	153.3	178.4	203.5	136
30.7	36.2	41.5	46.7	51.9	57.1	69.4	82.6	97.8	107.9	115.4	135.6	158.2	183.3	208.3	137
...	41.7	54.7	68.3	83.8	94.0	101.6	121.9	144.6	169.8	194.9	138
...	56.3	72.2	82.7	90.4	110.9	133.8	159.1	184.3	139
...	62.6	73.4	81.3	102.0	125.1	150.5	175.8	140
■ 0.78	■ 0.81	■ 0.82	■ 0.85	■ 0.87	■ 0.86	■ 0.91	■ 0.92	■ 0.94	■ 0.96	■ 0.98	■ 1.01	■ 1.04	■ 1.06	■ 1.08	■
...	...	36.3	41.7	47.1	52.3	64.8	78.1	93.4	103.5	111.1	131.2	153.9	179.0	204.1	141
...	56.9	72.9	83.3	91.1	111.6	134.5	159.8	185.0	142
...	42.3	55.3	69.0	84.5	94.7	102.3	122.6	145.4	170.5	195.7	143
...	63.4	74.1	82.1	102.9	125.9	151.4	176.7	144
...	...	36.7	42.2	47.5	52.8	65.3	78.6	93.9	104.0	111.6	131.8	154.4	179.5	204.6	145
■		■ 0.80	■ 0.83	■ 0.86	■ 0.86	■ 0.90	■ 0.92	■ 0.94	■ 0.96	■ 0.98	■ 1.01	■ 1.03	■ 1.06	■ 1.08	■
...	57.6	73.6	84.0	91.8	112.3	135.2	160.5	185.7	146
...	64.0	74.8	82.7	103.5	126.6	152.1	177.4	147
...	37.3	43.0	56.0	69.6	85.1	95.4	103.0	123.3	146.1	171.3	196.4	148
...	43.6	58.2	74.2	84.7	92.5	113.0	135.9	161.2	186.5	149
...	64.7	75.4	83.4	104.2	127.3	152.8	178.1	150
■				■ 0.77	■ 0.81	■ 0.83	■ 0.88	■ 0.91	■ 0.94	■ 0.96	■ 0.99	■ 1.02	■ 1.05	■ 1.07	■

▲ Not all available belt lengths are shown.

■ Combined Arc-Length correction factors for 5 preceding lines.



8VX & 8V BELTS IN 8V SHEAVES

LINE #	RATIO	STOCK SHEAVES			DRIVEN SPEEDS AND HORSEPOWER RATINGS PER BELT					
		Datum Diameter		Number Grooves	870 MOTOR		1160 MOTOR		1750 MOTOR	
		DR	DN		Driven Speed	H.P. Ratings	Driven Speed	H.P. Ratings	Driven Speed	H.P. Ratings
151	4.02	13.20	53.00	4-6,8,10,12	217	44.86	289	55.10	436	67.39
152	4.18	17.00	71.00	6,8,10,12	208	64.80	278	78.22
153	4.20	15.00	63.00	6,8,10,12	207	54.53	276	66.53
154	4.24	12.50	53.00	4-6,8,10,12	205	41.01	274	50.45	413	62.28
155	4.44	16.00	71.00	6,8,10,12	196	59.74	261	72.52
156	4.50	14.00	63.00	6,8,10,12	193	49.22	258	60.29	389	72.82
157	4.73	15.00	71.00	6,8,10,12	184	54.54	245	66.54
158	4.77	13.20	63.00	6,8,10,12	182	44.88	243	55.12	367	67.42
159	5.04	12.50	63.00	6,8,10,12	173	41.02	230	50.47	347	62.31
160	5.07	14.00	71.00	6,8,10,12	172	49.23	229	60.31	345	72.84
161	5.38	13.20	71.00	6,8,10,12	162	44.89	216	55.13	325	67.44
162	5.68	12.50	71.00	6,8,10,12	153	41.03	204	50.48	308	62.33

DRIVE SELECTION TABLES



CENTER DISTANCE AND COMBINED ARC-LENGTH CORRECTION FACTOR ▲											LINE #
8VX 1900	8VX 2000	8V 2240	8V 2500	8V 2800	8V 3000	8V 3150	8V 3550	8V 4000	8V 4500	8V 5000	
37.8	43.4	56.5	70.2	85.7	95.9	103.6	123.9	146.7	171.9	197.0	151
...	48.3	65.3	76.1	84.0	104.9	128.0	153.5	178.8	152
...	...	44.2	58.8	74.9	85.4	93.1	113.7	136.6	162.0	187.2	153
38.2	43.9	57.0	70.7	86.2	96.4	104.1	124.4	147.2	172.4	197.5	154
...	48.9	65.9	76.7	84.7	105.6	128.7	154.2	179.6	155
■ 0.77	0.81	0.84	0.85	0.91	0.94	0.96	0.99	1.02	1.05	1.07 ■	
...	...	44.8	59.5	75.6	86.0	93.8	114.4	137.3	162.7	187.9	156
...	49.5	66.6	77.4	85.4	106.3	129.4	154.9	180.3	157
...	...	45.3	60.0	76.1	86.6	94.4	115.0	137.9	163.3	188.5	158
...	...	45.7	60.4	76.5	87.0	94.8	115.4	138.4	163.8	189.0	159
...	50.1	67.2	78.0	86.0	106.9	130.1	155.6	181.0	160
■		0.78	0.83	0.90	0.93	0.95	0.98	1.02	1.05	1.07 ■	
...	50.6	67.7	78.6	86.5	107.5	130.7	156.2	181.6	161
...	51.0	68.1	79.0	87.0	108.0	131.2	156.7	182.1	162
			0.78	0.87	0.91	0.93	0.97	1.01	1.04	1.06 ■	

▲ Not all available belt lengths are shown.

■ Combined Arc-Length correction factors for 5 preceding lines.



HORSEPOWER RATINGS for 3VX BELTS

Narrow Cog horsepower ratings per belt are listed below and on the facing page. To obtain the basic horsepower rating per belt, locate the RPM of the faster shaft in the left-hand column. Read on this line across to the column headed by the diameter of the smaller sheave. The figure given is the basic horsepower rating. For convenience the standard motor speeds are grouped at the beginning of the chart. On the same horizontal line read the "add-on" rating in the column headed by the drive speed ratio. Add the basic rating to the "add-on" rating to obtain the total horsepower rating per belt.

RPM of Faster Shaft	BASIC HORSEPOWER RATING PER BELT													
	SMALL SHEAVE OUTSIDE DIAMETER													
	2.20	2.35	2.50	2.65	2.80	3.00	3.15	3.35	3.65	4.12	4.50	4.75	5.00	5.30
1160	1.04	1.22	1.40	1.58	1.75	1.99	2.16	2.39	2.74	3.28	3.71	3.99	4.27	4.60
1460	1.26	1.48	1.70	1.92	2.14	2.43	2.64	2.93	3.36	4.02	4.55	4.89	5.24	5.65
1750	1.46	1.72	1.98	2.24	2.49	2.84	3.09	3.43	3.93	4.71	5.33	5.73	6.14	6.61
2900	2.16	2.58	2.99	3.39	3.80	4.33	4.73	5.25	6.03	7.22	8.16	8.77	9.36	10.1
3500	2.49	2.98	3.46	3.94	4.41	5.03	5.50	6.11	7.01	8.38	9.46	10.1	10.8	11.6
600	0.60	0.70	0.79	0.89	0.99	1.11	1.21	1.33	1.52	1.81	2.05	2.20	2.36	2.54
700	0.68	0.80	0.91	1.02	1.13	1.28	1.38	1.53	1.75	2.09	2.36	2.53	2.71	2.92
800	0.76	0.89	1.02	1.14	1.27	1.43	1.56	1.72	1.97	2.35	2.66	2.86	3.06	3.30
900	0.84	0.98	1.13	1.27	1.41	1.59	1.73	1.91	2.19	2.61	2.96	3.18	3.40	3.67
1000	0.92	1.08	1.23	1.39	1.54	1.75	1.90	2.10	2.40	2.87	3.25	3.49	3.74	4.03
1200	1.07	1.26	1.44	1.62	1.80	2.05	2.23	2.47	2.82	3.38	3.82	4.11	4.40	4.75
1400	1.21	1.43	1.64	1.85	2.06	2.34	2.55	2.82	3.23	3.87	4.38	4.72	5.05	5.44
1600	1.35	1.60	1.84	2.07	2.31	2.63	2.86	3.17	3.64	4.35	4.93	5.30	5.67	6.12
1800	1.49	1.76	2.02	2.29	2.55	2.90	3.17	3.51	4.03	4.82	5.46	5.88	6.29	6.78
2000	1.62	1.92	2.21	2.50	2.79	3.18	3.46	3.84	4.41	5.28	5.98	6.43	6.88	7.42
2200	1.75	2.07	2.39	2.71	3.02	3.44	3.76	4.17	4.78	5.73	6.49	6.98	7.46	8.04
2400	1.87	2.22	2.57	2.91	3.25	3.70	4.04	4.49	5.15	6.17	6.98	7.51	8.03	8.64
2600	1.99	2.37	2.74	3.11	3.47	3.96	4.32	4.80	5.51	6.60	7.46	8.02	8.58	9.23
2800	2.11	2.51	2.90	3.30	3.69	4.21	4.59	5.10	5.86	7.01	7.93	8.52	9.11	9.79
3000	2.22	2.65	3.07	3.49	3.90	4.45	4.86	5.40	6.20	7.42	8.38	9.01	9.62	10.3
3200	2.33	2.78	3.23	3.67	4.11	4.69	5.12	5.69	6.53	7.81	8.82	9.47	10.1	10.9
3400	2.44	2.91	3.38	3.85	4.31	4.92	5.37	5.97	6.85	8.19	9.25	9.93	10.6	11.4
3600	2.54	3.04	3.53	4.02	4.51	5.15	5.62	6.24	7.16	8.56	9.66	10.4	11.0	11.8
3800	2.64	3.16	3.68	4.19	4.70	5.37	5.86	6.51	7.47	8.92	10.1	10.8	11.5	12.3
4000	2.74	3.29	3.82	4.36	4.89	5.58	6.10	6.77	7.76	9.27	10.4	11.2	11.9	12.7
4200	2.83	3.40	3.96	4.52	5.07	5.79	6.32	7.02	8.05	9.60	10.8	11.6	12.3	13.1
4400	2.93	3.52	4.10	4.68	5.24	5.99	6.54	7.27	8.32	9.92	11.1	11.9	12.7	13.5
4600	3.01	3.63	4.23	4.83	5.42	6.19	6.76	7.50	8.59	10.2	11.5	12.2	13.0	13.9
4800	3.10	3.73	4.36	4.97	5.58	6.38	6.96	7.73	8.84	10.5	11.8	12.6	13.3	14.2*
5000	3.18	3.84	4.48	5.12	5.74	6.56	7.16	7.95	9.09	10.8	12.1	12.9	13.6	14.5*

* Made-to-order ductile iron sheaves required.

HORSEPOWER RATINGS for 3VX BELTS



The combined Arc-Length correction factor shown in the Narrow pre-engineered drive tables or in the Arc-of-Contact correction factor table and the Belt Length correction factor table, page B1-16, should be applied to the total HP per belt before determining the number of belts required for the drive.

NOTE: These ratings apply for the Narrow Cog type belts only.

BASIC HORSEPOWER RATING PER BELT						"ADD-ON" RATING								
SMALL SHEAVE OUTSIDE DIAMETER						SPEED RATIO								
5.60	6.00	6.50	6.90	8.00	10.60	1.00 1.01	1.02 1.05	1.06 1.09	1.10 1.14	1.15 1.19	1.20 1.29	1.30 1.49	1.50 1.99	2.00 9.99
4.94	5.38	5.92	6.35	7.52	10.2	0.00	0.03	0.06	0.08	0.10	0.13	0.16	0.18	0.20
6.05	6.59	7.25	7.78	9.19	12.4	0.01	0.04	0.07	0.10	0.13	0.16	0.20	0.23	0.26
7.09	7.71	8.48	9.09	10.7	14.3	0.01	0.04	0.08	0.12	0.15	0.19	0.23	0.28	0.31
10.8	11.7	12.7	13.6	15.7	19.8*	0.01	0.07	0.14	0.20	0.25	0.31	0.39	0.46	0.51
12.4	13.4	14.5	15.4	17.6*	21.0*	0.01	0.09	0.17	0.24	0.31	0.38	0.47	0.55	0.61
2.72	2.96	3.26	3.50	4.16	5.66	0.00	0.01	0.03	0.04	0.05	0.07	0.08	0.09	0.11
3.13	3.41	3.76	4.03	4.78	6.51	0.00	0.02	0.03	0.05	0.06	0.08	0.09	0.11	0.12
3.53	3.85	4.24	4.55	5.40	7.34	0.00	0.02	0.04	0.06	0.07	0.09	0.11	0.13	0.14
3.93	4.28	4.72	5.06	6.00	8.15	0.00	0.02	0.04	0.06	0.08	0.10	0.12	0.14	0.16
4.32	4.71	5.18	5.56	6.59	8.95	0.00	0.02	0.05	0.07	0.09	0.11	0.13	0.16	0.18
5.09	5.54	6.10	6.55	7.75	10.5	0.00	0.03	0.06	0.08	0.11	0.13	0.16	0.19	0.21
5.83	6.35	6.99	7.50	8.86	11.9	0.01	0.03	0.07	0.10	0.12	0.15	0.19	0.22	0.25
6.56	7.14	7.85	8.42	9.94	13.3	0.01	0.04	0.08	0.11	0.14	0.17	0.21	0.25	0.28
7.26	7.90	8.69	9.31	11.0	14.6	0.01	0.04	0.09	0.12	0.16	0.20	0.24	0.28	0.32
7.95	8.64	9.49	10.2	11.9	15.8	0.01	0.05	0.10	0.14	0.18	0.22	0.27	0.32	0.35
8.61	9.36	10.3	11.0	12.9	16.9	0.01	0.05	0.11	0.15	0.19	0.24	0.29	0.35	0.39
9.25	10.0	11.0	11.8	13.8	17.9*	0.01	0.06	0.11	0.17	0.21	0.26	0.32	0.38	0.42
9.87	10.7	11.7	12.5	14.6	18.7*	0.01	0.06	0.12	0.18	0.23	0.28	0.35	0.41	0.46
10.5	11.4	12.4	13.2	15.4	19.5*	0.01	0.07	0.13	0.19	0.25	0.30	0.38	0.44	0.49
11.0	12.0	13.1	13.9	16.1	20.1*	0.01	0.07	0.14	0.21	0.26	0.33	0.40	0.47	0.53
11.6	12.5	13.7	14.5	16.7*	20.5*	0.01	0.08	0.15	0.22	0.28	0.35	0.43	0.51	0.56
12.1	13.1	14.3	15.1	17.3*	20.9*	0.01	0.08	0.16	0.23	0.30	0.37	0.46	0.54	0.60
12.6	13.6	14.8	15.7	17.8*	21.0*	0.01	0.09	0.17	0.25	0.32	0.39	0.48	0.57	0.63
13.1	14.1	15.3	16.2*	18.3*	...	0.01	0.09	0.18	0.26	0.33	0.41	0.51	0.60	0.67
13.5	14.5	15.7*	16.6*	18.6*	...	0.02	0.10	0.19	0.28	0.35	0.43	0.54	0.63	0.70
13.9	15.0*	16.1*	17.0*	18.9*	...	0.02	0.10	0.20	0.29	0.37	0.46	0.56	0.66	0.74
14.3	15.3*	16.5*	17.3*	19.1*	...	0.02	0.11	0.21	0.30	0.39	0.48	0.59	0.70	0.77
14.7*	15.7*	16.8*	17.6*	19.2*	...	0.02	0.11	0.22	0.32	0.40	0.50	0.62	0.73	0.81
15.0*	16.0*	17.1*	17.8*	0.02	0.12	0.23	0.33	0.42	0.52	0.64	0.76	0.84
15.3*	16.2*	17.3*	18.0*	0.02	0.12	0.24	0.35	0.44	0.54	0.67	0.79	0.88



HORSEPOWER RATINGS for 5VX BELTS

Narrow Cog horsepower ratings per belt are listed below and on the facing page. To obtain the basic horsepower rating per belt, locate the RPM of the faster shaft in the left-hand column. Read on this line across to the column headed by the diameter of the smaller sheave. The figure given is the basic horsepower rating. For convenience the standard motor speeds are grouped at the beginning of the chart. On the same horizontal line read the "add-on" rating in the column headed by the drive speed ratio. Add the basic rating to the "add-on" rating to obtain the total horsepower rating per belt.

RPM of Faster Shaft	BASIC HORSEPOWER RATING PER BELT																
	SMALL SHEAVE OUTSIDE DIAMETER																
	4.40	4.65	4.90	5.20	5.50	5.90	6.30	6.70	7.10	7.50	8.00	8.50	9.00	9.25	9.75	10.30	10.90
1160	6.22	7.03	7.83	8.78	9.73	11.0	12.2	13.5	14.7	15.9	17.5	19.0	20.4	21.2	22.6	24.2	26.0
1460	7.52	8.51	9.49	10.7	11.8	13.4	14.9	16.4	17.9	19.4	21.2	23.1	24.9	25.7	27.5	29.4	31.5
1750	8.70	9.86	11.0	12.4	13.8	15.6	17.3	19.1	20.8	22.6	24.7	26.8	28.8	29.8	31.8	34.0	36.3
2900	12.7	14.5	16.2	18.3	20.3	23.0	25.6	28.1	30.6	32.9	35.8	38.5	41.2*	42.4*	44.8*	47.3*	49.8*
3500	14.4	16.4	18.4	20.8	23.0	26.0	28.9	31.6	34.2	36.8*	39.7*	42.5*	45.0*	46.2*	48.4*	50.5*	52.4*
400	2.51	2.81	3.11	3.47	3.83	4.30	4.77	5.24	5.70	6.17	6.75	7.32	7.90	8.18	8.75	9.38	10.1
500	3.05	3.42	3.79	4.23	4.66	5.25	5.82	6.40	6.98	7.55	8.26	8.97	9.67	10.0	10.7	11.5	12.3
600	3.56	4.00	4.44	4.96	5.48	6.17	6.85	7.54	8.22	8.89	9.73	10.6	11.4	11.8	12.6	13.5	14.5
700	4.07	4.57	5.07	5.68	6.28	7.07	7.86	8.65	9.43	10.2	11.2	12.1	13.1	13.6	14.5	15.6	16.7
800	4.55	5.13	5.70	6.38	7.05	7.95	8.85	9.73	10.6	11.5	12.6	13.7	14.8	15.3	16.4	17.5	18.8
900	5.03	5.67	6.30	7.06	7.82	8.82	9.81	10.8	11.8	12.8	14.0	15.2	16.4	17.0	18.2	19.4	20.8
1000	5.50	6.20	6.90	7.73	8.56	9.67	10.8	11.8	12.9	14.0	15.3	16.7	18.0	18.6	19.9	21.3	22.9
1200	6.40	7.23	8.05	9.04	10.0	11.3	12.6	13.9	15.1	16.4	18.0	19.5	21.0	21.8	23.3	25.0	26.7
1400	7.26	8.22	9.17	10.3	11.4	12.9	14.4	15.8	17.3	18.7	20.5	22.3	24.0	24.9	26.6	28.4	30.4
1600	8.10	9.17	10.2	11.5	12.8	14.4	16.1	17.7	19.4	21.0	22.9	24.9	26.8	27.8	29.6	31.7	33.9
1800	8.89	10.1	11.3	12.7	14.1	15.9	17.7	19.5	21.3	23.1	25.3	27.4	29.5	30.5	32.5	34.7	37.1
2000	9.66	11.0	12.3	13.8	15.3	17.3	19.3	21.3	23.2	25.1	27.5	29.7	32.0	33.1	35.3	37.6	40.0
2200	10.4	11.8	13.2	14.9	16.5	18.7	20.8	22.9	25.0	27.1	29.5	32.0	34.3	35.5	37.8	40.2	42.7
2400	11.1	12.6	14.1	15.9	17.7	20.0	22.3	24.5	26.7	28.9	31.5	34.1	36.5	37.7	40.1	42.6	45.2*
2600	11.8	13.4	15.0	16.9	18.8	21.3	23.7	26.0	28.3	30.6	33.3	36.0	38.5	39.8	42.2*	44.7*	47.3*
2800	12.4	14.1	15.8	17.9	19.8	22.4	25.0	27.4	29.8	32.2	35.0	37.7	40.3*	41.6*	44.0*	46.5*	49.0*
3000	13.0	14.8	16.6	18.7	20.8	23.5	26.2	28.8	31.2	33.7	36.6	39.3*	41.9*	43.2*	45.6*	48.0*	50.5*
3200	13.6	15.5	17.4	19.6	21.8	24.6	27.3	30.0	32.5	35.0	37.9*	40.7*	43.3*	44.6*	46.9*	49.3*	51.6*
3400	14.1	16.1	18.1	20.4	22.6	25.6	28.4	31.1	33.7	36.2*	39.2*	41.9*	44.5*	45.7*	47.9*	50.2*	52.2*
3600	14.6	16.7	18.7	21.1	23.4	26.5	29.3	32.1	34.8*	37.3*	40.2*	42.9*	45.4*	46.6*	48.7*	50.7*	...
3800	15.1	17.2	19.3	21.8	24.2	27.3	30.2	33.0*	35.7*	38.2*	41.1*	43.7*	46.1*	47.2*	49.1*
4000	15.5	17.7	19.9	22.4	24.9	28.0	31.0*	33.8*	36.5*	38.9*	41.8*	44.3*	46.5*	47.5*
4200	15.9	18.2	20.4	23.0	25.5	28.7	31.7*	34.5*	37.1*	39.5*	42.3*	44.7*	46.7*
4400	16.3	18.6	20.9	23.5	26.0	29.2*	32.3*	35.0*	37.6*	40.0*	42.6*	44.8*
4600	16.6	19.0	21.3	24.0	26.5*	29.7*	32.7*	35.5*	38.0*	40.2*	42.7*

* Made-to-order ductile iron sheaves required.

HORSEPOWER RATINGS for 5VX BELTS



The combined Arc-Length correction factor shown in the Narrow pre-engineered drive tables or in the Arc-of-Contact correction factor table and the Belt Length correction factor table, page B1-16, should be applied to the total HP per belt before determining the number of belts required for the drive.

NOTE: These ratings apply for the Narrow Cog type belts only.

BASIC HORSEPOWER RATING PER BELT									"ADD-ON" RATING								
SMALL SHEAVE OUTSIDE DIAMETER									SPEED RATIO								
11.30	11.80	12.50	13.20	14.00	15.00	16.00	18.70	21.20	1.00 1.01	1.02 1.05	1.06 1.09	1.10 1.14	1.15 1.19	1.20 1.29	1.30 1.49	1.50 1.99	2.00 9.99
27.1	28.5	30.5	32.4	34.5	37.2	39.8	46.4	52.0	0.02	0.14	0.28	0.41	0.52	0.64	0.79	0.93	1.03
32.8	34.5	36.7	39.0	41.4	44.4	47.3	54.4*	60.1*	0.03	0.18	0.36	0.51	0.65	0.81	1.00	1.17	1.30
37.8	39.6	42.1	44.6	47.2	50.4*	53.3*	60.2*	65.1*	0.03	0.22	0.43	0.61	0.78	0.97	1.19	1.41	1.56
51.4*	53.1*	55.3*	0.06	0.36	0.71	1.02	1.29	1.60	1.98	2.33	2.59
...	0.07	0.44	0.85	1.23	1.56	1.93	2.39	2.81	3.12
10.5	11.1	11.8	12.6	13.5	14.6	15.7	18.6	21.3	0.01	0.05	0.10	0.14	0.18	0.22	0.27	0.32	0.36
12.9	13.6	14.5	15.5	16.5	17.9	19.2	22.8	26.0	0.01	0.06	0.12	0.18	0.22	0.28	0.34	0.40	0.45
15.2	16.0	17.1	18.2	19.5	21.1	22.6	26.8	30.5	0.01	0.07	0.15	0.21	0.27	0.33	0.41	0.48	0.54
17.4	18.4	19.6	20.9	22.4	24.2	26.0	30.6	34.9	0.01	0.09	0.17	0.25	0.31	0.39	0.48	0.56	0.62
19.6	20.7	22.1	23.5	25.2	27.2	29.2	34.4	39.0	0.02	0.10	0.19	0.28	0.36	0.44	0.55	0.64	0.71
21.8	22.9	24.5	26.1	27.9	30.1	32.3	37.9	42.9	0.02	0.11	0.22	0.32	0.40	0.50	0.61	0.72	0.80
23.9	25.1	26.9	28.6	30.5	32.9	35.2	41.3	46.6	0.02	0.12	0.24	0.35	0.45	0.55	0.68	0.80	0.89
27.9	29.3	31.3	33.3	35.5	38.2	40.8	47.5	53.2*	0.02	0.15	0.29	0.42	0.54	0.66	0.82	0.96	1.07
31.7	33.3	35.5	37.7	40.1	43.1	45.9	53.0*	58.7*	0.03	0.17	0.34	0.49	0.62	0.77	0.95	1.13	1.25
35.3	37.0	39.4	41.8	44.4	47.4	50.4*	57.5*	62.9*	0.03	0.20	0.39	0.56	0.71	0.88	1.09	1.29	1.43
38.6	40.5	43.0	45.4	48.1*	51.3*	54.2*	61.0*	65.7*	0.03	0.22	0.44	0.63	0.80	0.99	1.23	1.45	1.61
41.6	43.6	46.2	48.7*	51.4*	54.5*	57.3*	63.4*	...	0.04	0.25	0.49	0.70	0.89	1.10	1.36	1.61	1.78
44.4	46.4*	49.0*	51.5*	54.1*	57.1*	59.7*	0.04	0.27	0.54	0.77	0.98	1.21	1.50	1.77	1.96
46.8*	48.8*	51.4*	53.8*	56.3*	59.0*	0.05	0.30	0.58	0.84	1.07	1.32	1.64	1.93	2.14
48.9*	50.8*	53.3*	55.6*	57.8*	0.05	0.32	0.63	0.91	1.16	1.44	1.77	2.09	2.32
50.6*	52.5*	54.8*	56.8*	0.05	0.35	0.68	0.98	1.25	1.55	1.91	2.25	2.50
52.0*	53.7*	55.8*	0.06	0.37	0.73	1.05	1.34	1.66	2.05	2.41	2.68
52.9*	54.4*	0.06	0.40	0.78	1.12	1.43	1.77	2.18	2.57	2.85
...	0.07	0.42	0.83	1.19	1.52	1.88	2.32	2.73	3.03
...	0.07	0.45	0.88	1.26	1.61	1.99	2.45	2.89	3.21
...	0.07	0.47	0.92	1.33	1.69	2.10	2.59	3.05	3.39
...	0.08	0.50	0.97	1.40	1.78	2.21	2.73	3.21	3.57
...	0.08	0.52	1.02	1.47	1.87	2.32	2.86	3.38	3.75
...	0.08	0.55	1.07	1.54	1.96	2.43	3.00	3.54	3.92
...	0.09	0.57	1.12	1.62	2.05	2.54	3.14	3.70	4.10



HORSEPOWER RATINGS for 5V BELTS

Narrow V-Belt horsepower ratings per belt are listed below and on the facing page. To obtain the basic horsepower rating per belt, locate the rpm of the faster shaft in the left-hand column. Read on this line across to the column headed by the diameter of the smaller sheave. The figure given is the basic horsepower rating. For convenience the standard motor speeds are grouped at the beginning of the chart. On the same horizontal line read the “add-on” rating in the column headed by the drive speed ratio. Add the basic rating to the “add-on” rating to obtain the total horsepower rating per belt.

RPM of Faster Shaft	BASIC HORSEPOWER RATING PER BELT															
	SMALL SHEAVE OUTSIDE DIAMETER															
	7.10	7.50	8.00	8.50	9.00	9.25	9.75	10.00	10.30	10.90	11.00	11.30	11.80	12.00	12.50	13.00
1160	11.7	12.9	14.4	15.8	17.2	17.9	19.3	20.0	20.9	22.5	22.8	23.6	24.9	25.4	26.7	27.9
1460	14.0	15.4	17.2	18.9	20.6	21.4	23.1	23.9	24.8	26.7	27.0	27.9	29.4	30.0	31.4	32.8
1750	16.0	17.6	19.6	21.5	23.4	24.3	26.1	27.0	28.0	30.1	30.4	31.3	32.9	33.5	35.0	36.4
2900	21.2	23.1	25.4	27.6	29.5*	30.4*	32.0*	32.7*	33.5*	34.8*	35.0*	35.5*	36.1*	36.2*	36.5*	36.4*
3500	21.8	23.6*	25.6*	27.3*	28.6*	29.2*	30.0*	30.2*	30.4*	30.3*
400	4.75	5.21	5.78	6.35	6.92	7.20	7.77	8.05	8.38	9.05	9.16	9.50	10.1	10.3	10.8	11.4
500	5.77	6.33	7.04	7.73	8.43	8.78	9.47	9.81	10.2	11.0	11.2	11.6	12.3	12.5	13.2	13.9
600	6.75	7.42	8.25	9.07	9.89	10.3	11.1	11.5	12.0	13.0	13.1	13.6	14.4	14.7	15.5	16.3
700	7.70	8.47	9.42	10.4	11.3	11.8	12.7	13.2	13.7	14.8	15.0	15.5	16.4	16.8	17.7	18.6
800	8.62	9.49	10.6	11.6	12.7	13.2	14.2	14.8	15.4	16.6	16.8	17.4	18.4	18.8	19.8	20.8
900	9.52	10.5	11.7	12.8	14.0	14.6	15.7	16.3	17.0	18.3	18.5	19.2	20.3	20.7	21.8	22.9
1000	10.4	11.4	12.7	14.0	15.3	15.9	17.2	17.8	18.5	20.0	20.2	20.9	22.1	22.6	23.8	24.9
1200	12.0	13.3	14.8	16.2	17.7	18.4	19.9	20.6	21.4	23.1	23.4	24.2	25.5	26.1	27.4	28.7
1400	13.6	15.0	16.7	18.3	20.0	20.8	22.4	23.1	24.1	25.9	26.2	27.1	28.6	29.1	30.6	31.9
1600	15.0	16.5	18.4	20.2	22.0	22.9	24.6	25.5	26.5	28.4	28.7	29.7	31.2	31.8	33.3	34.7
1800	16.3	18.0	20.0	21.9	23.8	24.8	26.6	27.5	28.5	30.6	30.9	31.9	33.4	34.0	35.5	36.9
2000	17.5	19.3	21.4	23.5	25.5	26.4	28.3	29.2	30.3	32.3	32.7	33.6	35.2	35.8	37.2	38.5*
2200	18.6	20.4	22.7	24.8	26.8	27.8	29.7	30.6	31.7	33.7	34.0	34.9	36.4*	36.9*	38.2*	39.4*
2400	19.5	21.4	23.7	25.9	28.0	28.9	30.8	31.7	32.7	34.6*	34.9*	35.8*	37.1*	37.6*	38.6*	39.6*
2600	20.3	22.2	24.6	26.8	28.8	29.8	31.6*	32.4*	33.4*	35.1*	35.3*	36.1*	37.2*	37.5*	38.4*	39.0*
2800	20.9	22.9	25.2	27.4	29.3*	30.2*	31.9*	32.7*	33.5*	35.0*	35.2*	35.8*	36.6*	36.9*	37.3*	37.5*
3000	21.4	23.3	25.6	27.7*	29.6*	30.4*	31.9*	32.6*	33.3*	34.4*	34.6*	34.9*	35.4*	35.5*	35.5*	...
3200	21.7	23.6	25.8*	27.8*	29.5*	30.2*	31.5*	32.0*	32.5*	33.2*	33.3*	33.4*	33.4*
3400	21.8	23.7*	25.7*	27.5*	29.0*	29.6*	30.6*	30.9*	31.2*	31.4*	31.4*
3600	21.7*	23.5*	25.4*	27.0*	28.2*	28.6*	29.2*	29.4*	29.4*
3800	21.4*	23.1*	24.8*	26.1*	27.0*	27.2*	27.4*	27.3*
4000	21.0*	22.4*	23.9*	24.9*	25.3*	25.4*
4200	20.3*	21.5*	22.7*	23.3*	23.3*
4400	19.3*	20.4*	21.2*	21.3*
4600	18.2*	18.9*	19.3*

* Made-to-order ductile iron sheaves required.

HORSEPOWER RATINGS for 5V BELTS



The combined Arc-Length correction factor shown in the Narrow pre-engineered drive tables or in the Arc-of-Contact correction factor table and the Belt Length correction factor table, page B1-16, should be applied to the total HP per belt before determining the number of belts required for the drive.

NOTE: These ratings apply for the Narrow V-Belt type belts only.

BASIC HORSEPOWER RATING PER BELT							"ADD-ON" RATING								
SMALL SHEAVE OUTSIDE DIAMETER							SPEED RATIO								
13.20	13.50	14.00	15.00	16.00	18.70	21.20	1.00 1.01	1.02 1.05	1.06 1.09	1.10 1.14	1.15 1.19	1.20 1.29	1.30 1.49	1.50 1.99	2.00 9.99
28.4	29.2	30.4	32.8	35.1	40.7	45.1	0.03	0.19	0.37	0.53	0.67	0.83	1.03	1.21	1.35
33.4	34.2	35.5	38.0	40.3	45.5*	48.9*	0.04	0.24	0.46	0.67	0.85	1.05	1.30	1.53	1.69
36.9	37.7	39.0	41.3*	43.3*	47.1*	48.1*	0.04	0.28	0.55	0.80	1.02	1.26	1.55	1.83	2.03
...	0.07	0.47	0.92	1.32	1.68	2.08	2.57	3.03	3.37
...	0.09	0.57	1.11	1.60	2.03	2.51	3.10	3.66	4.06
11.6	11.9	12.5	13.5	14.6	17.5	20.0	0.01	0.07	0.13	0.18	0.23	0.29	0.35	0.42	0.46
14.1	14.5	15.2	16.5	17.8	21.2	24.3	0.01	0.08	0.16	0.23	0.29	0.36	0.44	0.52	0.58
16.6	17.0	17.8	19.3	20.8	24.8	28.3	0.01	0.10	0.19	0.27	0.35	0.43	0.53	0.63	0.70
18.9	19.4	20.3	22.0	23.7	28.2	32.1	0.02	0.11	0.22	0.32	0.41	0.50	0.62	0.73	0.81
21.2	21.8	22.7	24.6	26.5	31.3	35.5	0.02	0.13	0.25	0.37	0.46	0.57	0.71	0.84	0.93
23.3	24.0	25.0	27.1	29.1	34.3	38.7	0.02	0.15	0.28	0.41	0.52	0.65	0.80	0.94	1.04
25.4	26.1	27.2	29.4	31.5	36.9	41.5	0.02	0.16	0.32	0.46	0.58	0.72	0.89	1.05	1.16
29.2	29.9	31.2	33.6	35.9	41.5	45.8*	0.03	0.20	0.38	0.55	0.70	0.86	1.06	1.25	1.39
32.5	33.3	34.6	37.1	39.4	44.8*	48.5*	0.03	0.23	0.44	0.64	0.81	1.01	1.24	1.46	1.62
35.2	36.1	37.4	39.8	42.0*	46.7*	49.1*	0.04	0.26	0.51	0.73	0.93	1.15	1.42	1.67	1.86
37.4	38.2	39.5*	41.7*	43.6*	47.0*	47.5*	0.04	0.29	0.57	0.82	1.04	1.29	1.60	1.88	2.09
39.0*	39.7*	40.8*	42.7*	44.1*	45.6*	...	0.05	0.33	0.63	0.91	1.16	1.44	1.77	2.09	2.32
39.8*	40.4*	41.3*	42.7*	43.4*	0.05	0.36	0.70	1.00	1.28	1.58	1.95	2.30	2.55
39.9*	40.3*	40.9*	41.5*	0.06	0.39	0.76	1.10	1.39	1.72	2.13	2.51	2.79
39.1*	39.4*	39.5*	0.06	0.42	0.82	1.19	1.51	1.87	2.31	2.72	3.02
37.5*	37.4*	0.07	0.46	0.89	1.28	1.62	2.01	2.48	2.93	3.25
...	0.07	0.49	0.95	1.37	1.74	2.15	2.66	3.14	3.48
...	0.08	0.52	1.01	1.46	1.86	2.30	2.84	3.35	3.71
...	0.08	0.55	1.08	1.55	1.97	2.44	3.02	3.56	3.95
...	0.09	0.59	1.14	1.64	2.09	2.59	3.19	3.76	4.18
...	0.09	0.62	1.20	1.74	2.21	2.73	3.37	3.97	4.41
...	0.10	0.65	1.27	1.83	2.32	2.87	3.55	4.18	4.64
...	0.10	0.68	1.33	1.92	2.44	3.02	3.73	4.39	4.87
...	0.11	0.72	1.39	2.01	2.55	3.16	3.90	4.60	5.11
...	0.11	0.75	1.46	2.10	2.67	3.30	4.08	4.81	5.34



HORSEPOWER RATINGS for 8V and 8VX BELTS

Narrow V-Belt horsepower ratings per belt are listed below and on the facing page. To obtain the basic horsepower rating per belt, locate the RPM of the faster shaft in the left-hand column. Read on this line across to the column headed by the diameter of the smaller sheave. The figure given is the basic horsepower rating. For convenience the standard motor speeds are grouped at the beginning of the chart. On the same horizontal line read the "add-on" rating in the column headed by the drive speed ratio. Add the basic rating to the "add-on" rating to obtain the total horsepower rating per belt.

RPM of Faster Shaft	BASIC HORSEPOWER RATING PER BELT												
	SMALL SHEAVE OUTSIDE DIAMETER												
	12.50	13.20	14.00	15.00	16.00	17.00	18.00	19.00	20.00	21.20	22.40	24.80	30.00
870	36.1	40.0	44.3	49.6	54.8	59.9	64.8	69.6	74.3	79.7	84.9	94.5	111.9*
960	38.8	42.9	47.5	53.2	58.7	64.1	69.2	74.2	79.0	84.6	89.8	99.3	115.3*
1160	43.9	48.6	53.8	60.0	66.0	71.7	77.1	82.2	87.1	92.4	97.3*	105.4*	115.0*
1460	49.6	54.7	60.3	66.8	72.9	78.4	83.4*	87.8*	91.7*	95.4*	98.2*	100.8*	...
1750	52.4	57.6	63.0	69.0*	74.3*	78.6*	82.1*	84.6*	86.1*	86.4*
200	10.6	11.7	12.9	14.4	15.9	17.4	18.9	20.4	21.9	23.6	25.4	28.9	36.3
300	15.1	16.6	18.4	20.6	22.8	25.0	27.1	29.3	31.4	33.9	36.4	41.4	52.0
500	23.3	25.7	28.5	32.0	35.4	38.8	42.1	45.4	48.7	52.6	56.4	63.9	79.4
600	27.1	29.9	33.2	37.2	41.2	45.1	48.9	52.8	56.5	61.0	65.3	73.7	90.8
700	30.6	33.9	37.5	42.1	46.6	51.0	55.3	59.5	63.7	68.6	73.3	82.5	100.4
800	33.9	37.5	41.6	46.7	51.6	56.4	61.1	65.7	70.2	75.4	80.5	90.0	107.9
900	37.0	41.0	45.4	50.9	56.2	61.3	66.4	71.2	76.0	81.4	86.6	96.3	113.3*
1000	39.9	44.1	48.9	54.7	60.3	65.8	71.0	76.1	80.9	86.5	91.7	101.1	116.2*
1100	42.5	47.0	52.0	58.1	64.0	69.7	75.0	80.2	85.0	90.5	95.5	104.3*	116.3*
1200	44.8	49.6	54.8	61.2	67.2	72.9	78.4	83.5	88.2	93.4*	98.1*	105.8*	113.6*
1300	46.9	51.8	57.3	63.7	69.9	75.6	81.0	85.9	90.4*	95.2*	99.4*	105.5*	...
1400	48.7	53.7	59.3	65.8	71.9	77.6	82.7*	87.4*	91.5*	95.7*	99.1*	103.2*	...
1500	50.2	55.3	60.9	67.4	73.4	78.9*	83.7*	87.9*	91.5*	94.9*	97.3*	98.7*	...
1600	51.3	56.5	62.1	68.5	74.3*	79.4*	83.8*	87.4*	90.3*	92.7*	93.8*
1700	52.2	57.3	62.8	69.0*	74.4*	79.1*	82.9*	85.8*	87.8*	88.9*	88.5*
1800	52.6	57.7	63.0*	68.9*	73.9*	78.0*	81.0*	83.0*	84.0*	83.5*
1900	52.7	57.7*	62.7*	68.2*	72.6*	76.0*	78.1*	79.1*	78.7*
2000	52.4	57.2*	61.9*	66.9*	70.6*	73.0*	74.1*	73.8*
2100	51.8*	56.2*	60.6*	64.8*	67.7*	69.1*	68.9*
2200	50.7*	54.8*	58.6*	62.1*	64.0*	64.2*

* Made-to-order ductile iron sheaves required.

HORSEPOWER RATINGS for 8V and 8VX BELTS



The combined Arc-Length correction factor shown in the Narrow pre-engineered drive tables or in the Arc-of-Contact correction factor table and the Belt Length correction factor table, page B1-16, should be applied to the total HP per belt before determining the number of belts required for the drive.

"ADD-ON" RATING								
SPEED RATIO								
1.00	1.02	1.06	1.10	1.15	1.20	1.30	1.50	2.00
1.01	1.05	1.09	1.14	1.19	1.29	1.49	1.99	9.99
0.11	0.69	1.34	1.94	2.46	3.04	3.76	4.43	4.92
0.12	0.76	1.48	2.14	2.71	3.36	4.15	4.89	5.43
0.14	0.92	1.79	2.58	3.28	4.06	5.01	5.91	6.56
0.18	1.16	2.25	3.25	4.13	5.11	6.31	7.44	8.26
0.21	1.39	2.70	3.89	4.95	6.12	7.56	8.92	9.90
0.02	0.16	0.31	0.45	0.57	0.70	0.86	1.02	1.13
0.04	0.24	0.46	0.67	0.85	1.05	1.30	1.53	1.70
0.06	0.40	0.77	1.11	1.41	1.75	2.16	2.55	2.83
0.07	0.48	0.93	1.34	1.70	2.10	2.59	3.06	3.39
0.09	0.55	1.08	1.56	1.98	2.45	3.03	3.57	3.96
0.10	0.63	1.23	1.78	2.26	2.80	3.46	4.08	4.52
0.11	0.71	1.39	2.00	2.54	3.15	3.89	4.59	5.09
0.12	0.79	1.54	2.23	2.83	3.50	4.32	5.09	5.65
0.13	0.87	1.70	2.45	3.11	3.85	4.75	5.60	6.22
0.15	0.95	1.85	2.67	3.39	4.20	5.19	6.11	6.79
0.16	1.03	2.00	2.89	3.68	4.55	5.62	6.62	7.35
0.17	1.11	2.16	3.12	3.96	4.90	6.05	7.13	7.92
0.18	1.19	2.31	3.34	4.24	5.25	6.48	7.64	8.48
0.19	1.27	2.47	3.56	4.52	5.60	6.92	8.15	9.05
0.21	1.35	2.62	3.78	4.81	5.95	7.35	8.66	9.61
0.22	1.43	2.78	4.01	5.09	6.30	7.78	9.17	10.18
0.23	1.50	2.93	4.23	5.37	6.65	8.21	9.68	10.74
0.24	1.58	3.08	4.45	5.65	7.00	8.64	10.19	11.31
0.26	1.66	3.24	4.67	5.94	7.35	9.08	10.70	11.87
0.27	1.74	3.39	4.90	6.22	7.70	9.51	11.21	12.44

A Stock Part Won't Work On Your Drive?

*No Problem, Let Wood's Make A Part to **Your** Specifications.*

MTO's By Wood's

Material

Cast Iron

Used on all specials unless otherwise specified.
Safe on wheels operating up to 6,500 FPM.
Class 30 and Class 35 commonly poured
Other classes available upon request.

Ductile Iron

Used when specified by the customer.
Safe on wheels operating up to 10,000 FPM.
80-55-06 as cast, 65-45-12 annealed for high shock,
100-70-03 for maximum tensile available.

Balance

Static Balance

All wheels recommended to receive a minimum
of a (one plane) static balance or equivalent.

Dynamic

The need for dynamic (two plane) balance is
based on both rim speed and face width.

Bores

Wheels can be supplied bored to size, Sure-Grip bushed or clamp hub.
Special tolerances, tapered bores, splines, and metrics are also done.

Wheel Construction

Many different construction types are available from numerous arm configurations
to special web centered types with drilling to mount to existing equipment.

Below are some of the more common constructions.



Solid



Clamp Hub



Split



Split Thru Arm

Flywheels

Flywheels are often added to many rough or pulsating loads to smooth operation.
Flywheels to provide any desired WR2 can be supplied.
Consult with Wood's engineers to assist with design.

Idler Wheels

Idler wheels can be made to accommodate bronze bushings or roller bearings.
Information on the bearings or bushings to be used, RPM, radial loading, and hub location should be supplied.
Our Sure-Grip Idler bushings and stock components can be used on many applications.

Special Flat Pulleys and Taper Cones

Special conveyor pulleys, face lagging and tapered cones are also available.

Miscellaneous Castings

Our shop not only pours our own high quality castings, they also can pour your as-cast or fully machined parts.